

General Specifications

ROTAMASS Total Insight Coriolis Mass Flow and Density Meter Giga



GS 01U10B03-00EN-R



Scope of application

- Precise flow rate measurement of fluids and gases, multi-phase fluids and fluids with specific gas content using the Coriolis principle.
- Direct measurement of mass flow and density independent of the fluid's physical properties, such as density, viscosity and homogeneity
- Concentration measurement of solutions, suspensions and emulsions
- Fluid temperatures of $-70 - 350\text{ }^{\circ}\text{C}$ ($-94 - 662\text{ }^{\circ}\text{F}$)
- Process pressures up to 100 bar
- EN, ASME or JIS standard flange process connections up to three nominal diameters per meter size
- Connection to common process control systems, such as via HART, Modbus or PROFIBUS PA
- Hazardous area approvals: IECEx, ATEX, FM (USA/Canada), NEPSI, INMETRO, PESO, EAC, Taiwan Safety Label, Korea Ex, Japan Ex
- Safety-related applications: PED per AD 2000 Code, SIL 2, secondary containment up to 65 bar
- Marine type approval for Giga 1F: DNV GL

Advantages and benefits

- Inline measurement of several process variables, such as mass, density and temperature
- Advanced functions like Net Oil Computing, Batching function and Viscosity function to avoid external dedicated flow computer.
- Adapterless installation due to multi-size flange concept
- No straight pipe runs at inlet or outlet required
- Fast and uncomplicated commissioning and operation of the flow meter
- Maintenance-free operation
- Functions that can be activated subsequently (Features on Demand)
- Total Health Check (diagnostic function): Self-monitoring of the entire flow meter, including accuracy
- Maximum accuracy due to calibration facility accredited according to ISO/IEC 17025 (for option K5)
- Self-draining installation
- Vibration-resistant due to counterbalanced double-tube measurement system

Table of contents

1	Introduction	5
1.1	Applicable documents.....	5
1.2	Product overview	6
2	Measuring principle and flow meter design	7
2.1	Measuring principle.....	7
2.2	Flow meter	9
3	Application and measuring ranges	13
3.1	Measured quantities	13
3.2	Measuring range overview.....	13
3.3	Mass flow	14
3.4	Volume flow	14
3.5	Pressure loss	14
3.6	Density.....	14
3.7	Temperature	15
4	Accuracy	16
4.1	Overview	16
4.2	Zero point stability of the mass flow.....	16
4.3	Mass flow accuracy	17
4.3.1	Sample calculation for liquids	17
4.3.2	Sample calculation for gases	17
4.4	Accuracy of density.....	18
4.4.1	For liquids	18
4.4.2	For gases	18
4.5	Accuracy of mass flow and density according to the model code	19
4.5.1	For liquids	19
4.5.2	For gases	19
4.6	Volume flow accuracy.....	20
4.6.1	For liquids	20
4.6.2	For gases	20
4.7	Accuracy of temperature.....	20
4.8	Repeatability	21
4.9	Calibration conditions	22
4.9.1	Mass flow calibration and density adjustment.....	22
4.10	Process pressure effect	22
4.11	Process fluid temperature effect	23
5	Operating conditions	24
5.1	Location and position of installation.....	24
5.1.1	Sensor installation position	24
5.2	Installation instructions	25
5.3	Process conditions.....	26
5.3.1	Process fluid temperature range.....	26
5.3.2	Density	26
5.3.3	Pressure.....	26
5.3.4	Mass flow	29

5.3.5	Insulation and heat tracing	30
5.3.6	Secondary containment	30
5.4	Ambient conditions	31
5.4.1	Allowed ambient temperature for sensor	32
5.4.2	Temperature specification in hazardous areas	35
6	Mechanical specification	40
6.1	Design.....	40
6.2	Material	41
6.2.1	Material wetted parts.....	41
6.2.2	Non-wetted parts.....	41
6.3	Process connections, dimensions and weights of sensor	42
6.4	Transmitter dimensions and weights	51
7	Transmitter specification.....	53
7.1	HART and Modbus	54
7.1.1	Inputs and outputs	54
7.2	PROFIBUS PA.....	65
7.2.1	Overview of functional scope	65
7.2.2	Inputs and outputs	66
7.3	Power supply	68
7.4	Cable specification.....	68
8	Advanced functions and Features on Demand (FOD)	69
8.1	Concentration and petroleum measurement	70
8.2	Batching function	72
8.3	Viscosity function	73
8.4	Tube Health Check	74
8.5	Measurement of heat quantity	74
8.6	Features on Demand (FOD).....	75
9	Approvals and declarations of conformity	76
10	Ordering information.....	87
10.1	Overview model code Giga 1F	87
10.2	Overview model code Giga 2H.....	92
10.3	Overview options	96
10.4	Model code	103
10.4.1	Transmitter	103
10.4.2	Sensor.....	103
10.4.3	Meter size	104
10.4.4	Material wetted parts.....	104
10.4.5	Process connection size	104
10.4.6	Process connection type	104
10.4.7	Sensor housing material	105
10.4.8	Process fluid temperature range.....	105
10.4.9	Mass flow and density accuracy	106
10.4.10	Design and housing	106
10.4.11	Ex approval	107
10.4.12	Cable entries.....	107

- 10.4.13 Communication type and I/O 107
- 10.4.14 Display 110
- 10.5 Options 111
 - 10.5.1 Connecting cable type and length..... 112
 - 10.5.2 Additional nameplate information..... 112
 - 10.5.3 Presetting of customer parameters 112
 - 10.5.4 Concentration and petroleum measurement..... 113
 - 10.5.5 Batching function 113
 - 10.5.6 Viscosity function 113
 - 10.5.7 Insulation and heat tracing 114
 - 10.5.8 Certificates 114
 - 10.5.9 Country-specific delivery 117
 - 10.5.10 Country-specific application 117
 - 10.5.11 Rupture disc..... 117
 - 10.5.12 Tube Health Check 117
 - 10.5.13 Transmitter housing rotated 180° 118
 - 10.5.14 Measurement of heat quantity 118
 - 10.5.15 Marine approval 119
 - 10.5.16 Cable glands and blind plug..... 119
 - 10.5.17 Customized installation length 119
 - 10.5.18 Customer-specific special product manufacture 120
- 10.6 Ordering Instructions 121

1 Introduction

1.1 Applicable documents

For Ex approval specification, refer to the following documents:

- Explosion Proof Type Manual ATEX IM 01U10X01-00__-R¹⁾
- Explosion Proof Type Manual IECEx IM 01U10X02-00__-R¹⁾
- Explosion Proof Type Manual FM IM 01U10X03-00__-R¹⁾
- Explosion Proof Type Manual INMETRO IM 01U10X04-00__-R¹⁾
- Explosion Proof Type Manual PESO IM 01U10X05-00__-R¹⁾
- Explosion Proof Type Manual NEPSI IM 01U10X06-00__-R¹⁾
- Explosion Proof Type Manual KOREA Ex IM 01U10X07-00__-R¹⁾
- Explosion Proof Type Manual EAC Ex IM 01U10X08-00__-R¹⁾
- Explosion Proof Type Manual Japan Ex IM 01U10X09-00__-R¹⁾

Other applicable User's manuals:

- Protection of Environment (Use in China only) IM 01A01B01-00ZH-R







¹⁾ The "_" symbols are placeholders. Here for example, for the corresponding language version (DE, EN, etc.).

1.2 Product overview

Rotamass Total Insight Coriolis mass flow and density meters are available in various product families distinguished by their applications. Each product family includes several product alternatives and additional device options that can be selected.

The following overview serves as a guide for selecting products.

Overview of Rotamass Total Insight product families

<p>Rotamass Nano</p>		<p>For low flow rate applications Meter sizes: Nano 06, Nano 08, Nano 10, Nano 15, Nano 20 Connection sizes: <ul style="list-style-type: none"> ▪ DN15, DN25, DN40 ▪ 1/4", 3/8", 1/2", 3/4", 1", 1 1/2" Maximum mass flow: 1.5 t/h (55 lb/min)</p>
<p>Rotamass Prime</p>		<p>Versatility with superior turndown and low pressure loss Meter sizes: Prime 25, Prime 40, Prime 50, Prime 80, Prime 1H Connection sizes: <ul style="list-style-type: none"> ▪ DN15, DN25, DN40, DN50, DN80, DN100, DN125 ▪ 3/8", 1/2", 3/4", 1", 1 1/2", 2", 2 1/2", 3", 4", 5" Maximum mass flow: 255 t/h (9400 lb/min)</p>
<p>Rotamass Supreme</p>		<p>Excellent performance under demanding conditions Meter sizes: Supreme 34, Supreme 36, Supreme 38, Supreme 39 Connection sizes: <ul style="list-style-type: none"> ▪ DN15, DN25, DN40, DN50, DN65, DN80, DN100, DN125 ▪ 3/8", 1/2", 3/4", 1", 1 1/2", 2", 2 1/2", 3", 4", 5" Maximum mass flow: 170 t/h (6200 lb/min)</p>
<p>Rotamass Intense</p>		<p>For high process pressure applications Meter sizes: Intense 34, Intense 36, Intense 38 Connection sizes: <ul style="list-style-type: none"> ▪ 3/8", 1/2", 3/4", 1", 2" Maximum mass flow: 50 t/h (1800 lb/min)</p>
<p>Rotamass Hygienic</p>		<p>For food, beverage and pharmaceutical applications Meter sizes: Hygienic 25, Hygienic 40, Hygienic 50, Hygienic 80 Connection sizes: <ul style="list-style-type: none"> ▪ DN25, DN40, DN50, DN65, DN80 ▪ 1", 1 1/2", 2", 2 1/2", 3" Maximum mass flow: 76 t/h (2800 lb/min)</p>
<p>Rotamass Giga</p>		<p>For high flow rate applications Meter sizes: Giga 1F, Giga 2H Connection sizes: <ul style="list-style-type: none"> ▪ DN100, DN125, DN150, DN200 ▪ 4", 5", 6", 8" Maximum mass flow: 600 t/h (22000 lb/min)</p>

2 Measuring principle and flow meter design

2.1 Measuring principle

The measuring principle is based on the generation of Coriolis forces. For this purpose, a driver system (E) excites the two measuring tubes (M1, M2) in their first resonance frequency. Both pipes vibrate inversely phased, similar to a resonating tuning fork.

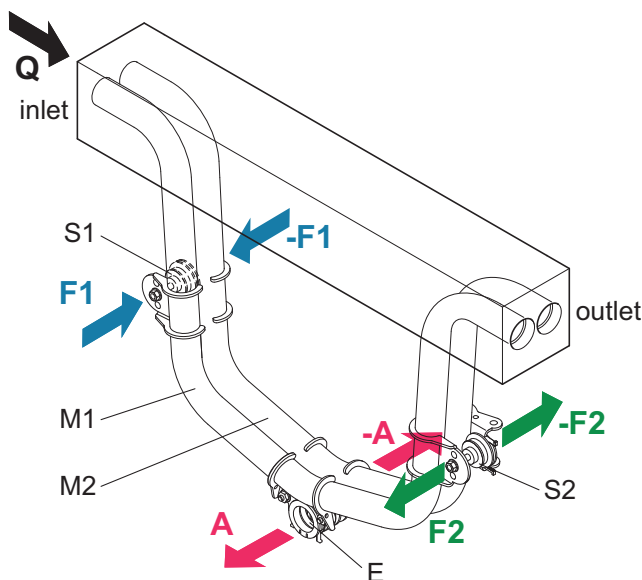

Fig. 1: Coriolis principle

M1, M2	Measuring tubes	E	Driver system
S1, S2	Pick-offs	A	Direction of measuring tube vibration
F1, F2	Coriolis forces	Q	Direction of fluid flow

Mass flow

The fluid flow through the vibrating measuring tubes generates Coriolis forces (F1, -F1 and F2, -F2) that produce positive or negative values for the tubes on the inflow or outflow side. These forces are directly proportional to the mass flow and result in deformation (torsion) of the measuring tubes.

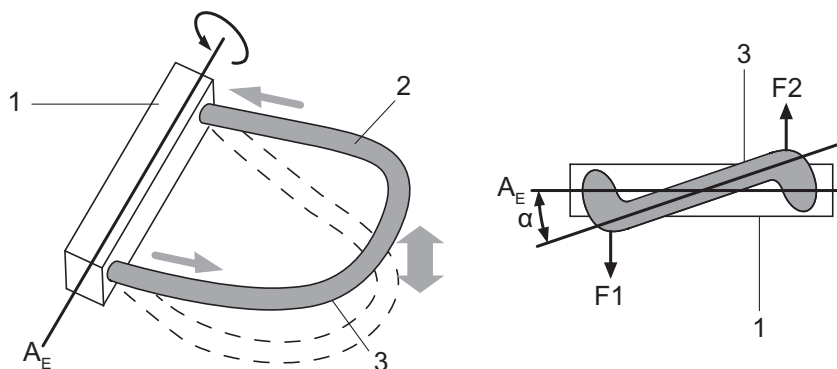

Fig. 2: Coriolis forces and measuring tube deformation

1	Measuring tube mount	A_E	Rotational axis
2	Fluid	F1, F2	Coriolis forces
3	Measuring tube	α	Torsion angle

The small deformation overlying the fundamental vibration is recorded by means of pick-offs (S1, S2) attached at suitable measuring tube locations. The resulting phase shift $\Delta\phi$ between the output signals of pick-offs S1 and S2 is proportional to the mass flow. The output signals generated are further processed in a transmitter.

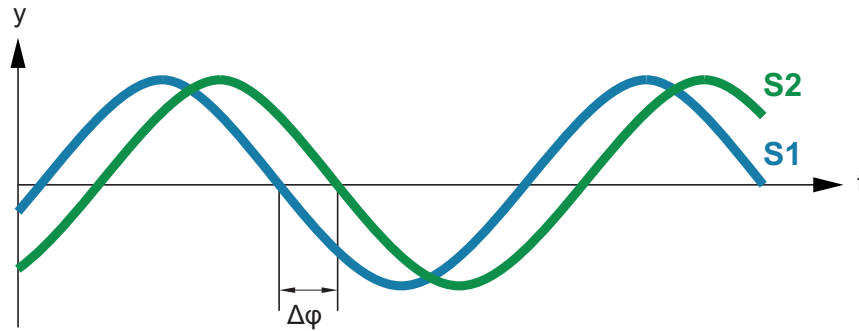

Fig. 3: Phase shift between output signals of S1 and S2 pick-offs

$$\Delta\phi \sim F_c \sim \frac{dm}{dt}$$

- $\Delta\phi$ Phase shift
- m Dynamic mass
- t Time
- dm/dt Mass flow
- F_c Coriolis force

Density measurement

Using a driver and an electronic regulator, the measuring tubes are operated in their resonance frequency f . This resonance frequency is a function of measuring tube geometry, material properties and the mass of the fluid covibrating in the measuring tubes. Altering the density and the attendant mass will alter the resonance frequency. The transmitter measures the resonance frequency and calculates density from it according to the formula below. Device-dependent constants are determined individually during calibration.

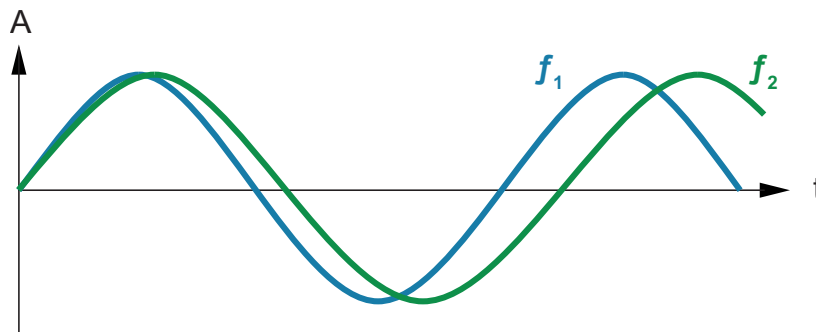

Fig. 4: Resonance frequency of measuring tubes

- A Measuring tube displacement
- f_1 Resonance frequency with fluid 1
- f_2 Resonance frequency with fluid 2

$$\rho = \frac{\alpha}{f^2} + \beta$$

- ρ Fluid density
- f Resonance frequency of measuring tubes
- α, β Device-dependent constants

Temperature measurement

The measuring tube temperature is measured in order to compensate the effects of temperature on the flow meter. This temperature approximately equals the fluid temperature and is made available as a measured quantity at the transmitter as well.

2.2 Flow meter

The Rotamass Coriolis flow meter consists of:

- Sensor
- Transmitter

When the integral type is used, sensor and transmitter are firmly connected.

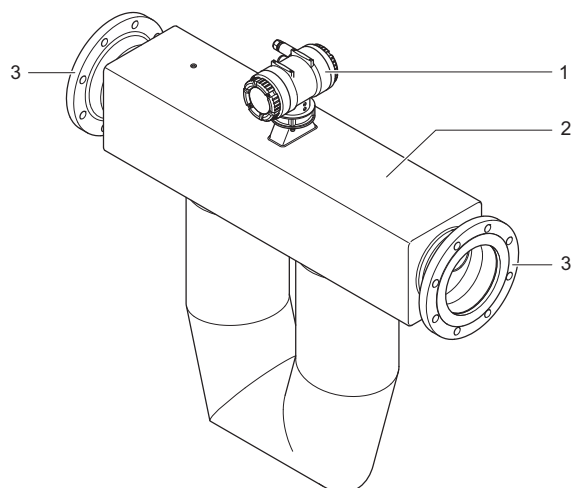

Fig. 5: Configuration of the Rotamass integral type

- | | |
|---|---------------------|
| 1 | Transmitter |
| 2 | Sensor |
| 3 | Process connections |

When the remote type is used, sensor and transmitter are linked via connecting cable. As a result, sensor and transmitter can be installed in different locations.

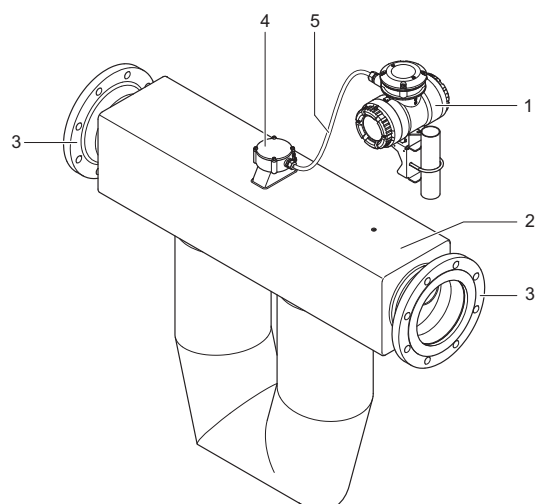

Fig. 6: Configuration of the Rotamass remote type

- | | | | |
|---|---------------------|---|---------------------|
| 1 | Transmitter | 4 | Sensor terminal box |
| 2 | Sensor | 5 | Connecting cable |
| 3 | Process connections | | |

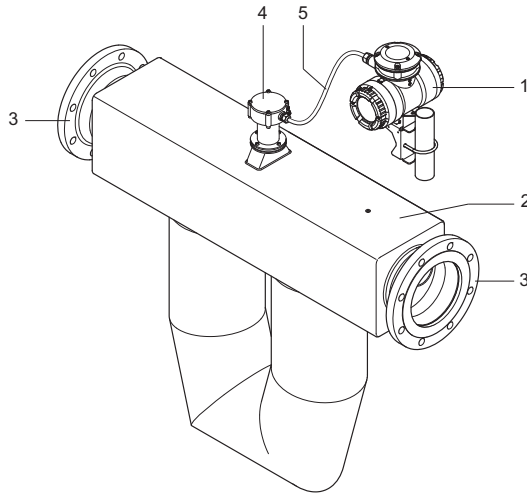

Fig. 7: Configuration of the Rotamass remote type - long neck

- | | | | |
|---|---------------------|---|---------------------|
| 1 | Transmitter | 4 | Sensor terminal box |
| 2 | Sensor | 5 | Connecting cable |
| 3 | Process connections | | |

General specifications

All available properties of the Rotamass Coriolis flow meter are specified by means of a model code.

One model code position may include several characters depicted by means of dashed lines.

The positions of the model code relevant for the respective properties are depicted and highlighted in blue. Any values that might occupy these model code positions are subsequently explained.

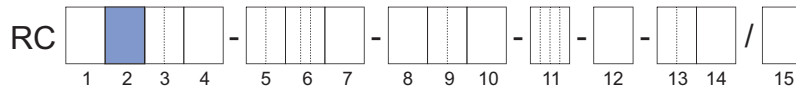

Fig. 8: Highlighted model code positions

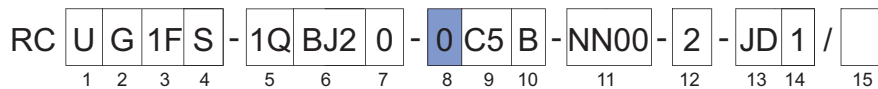
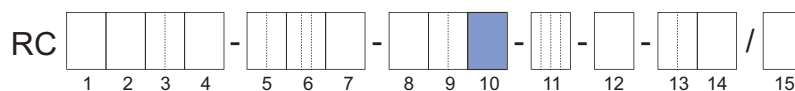

Fig. 9: Example of a completed model code

A complete description of the model code is included in the chapter *Ordering information* [87].

Type of design

Position 10 of the model code defines whether the integral type or the remote type is used. It specifies further flow meter properties, such as the transmitter coating, see *Design and housing* [106].



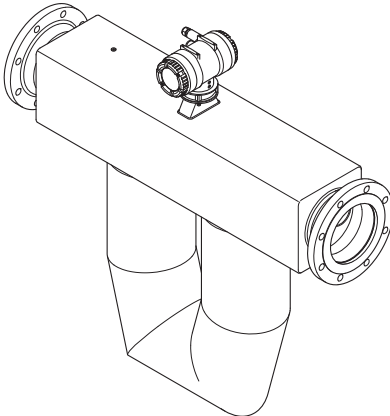
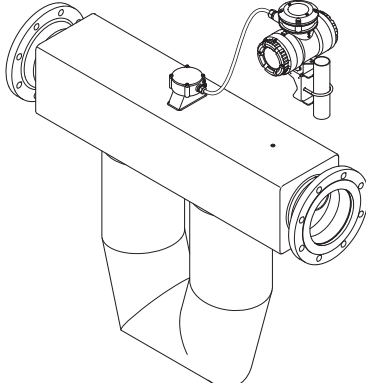
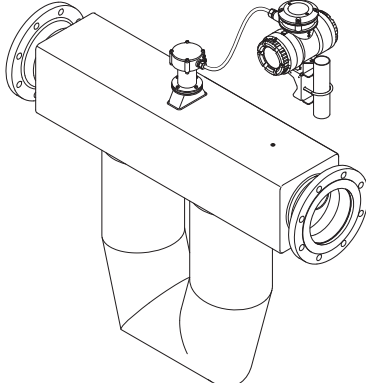

Flow meter	Model code position 10
<p>Integral type</p> 	<p>0, 2</p>
<p>Remote type - standard neck</p> 	<p>A, E, J</p>
<p>Remote type - long neck</p> 	<p>B, F, K</p>

Transmitter overview Two different transmitters can be combined with the sensor: Essential and Ultimate.

Essential transmitter is suitable for general purposes applications and it delivers accurate and precise measurements of flow rate and density.

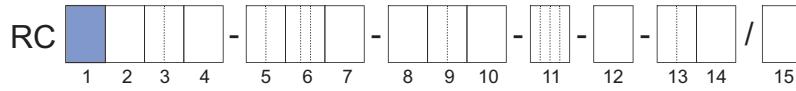
Ultimate transmitter, thanks to the advanced functions and "Features on Demand", offers dedicated application solutions with a superior accuracy and performances in measuring flow rate, density and concentration.



Transmitter	Properties	Model code position 1
<p>Essential</p> 	<ul style="list-style-type: none"> Down to 0.2 % mass flow accuracy for liquids Down to 0.75 % mass flow accuracy for gases Down to 4 g/l (0.25 lb/ft³) accuracy for density Total Health Check (diagnostic function) Advanced functions: <ul style="list-style-type: none"> Tube Health Check (diagnostic function) Communication: <ul style="list-style-type: none"> HART Modbus Data backup on microSD card 	E
<p>Ultimate</p> 	<ul style="list-style-type: none"> Down to 0.1 % mass flow accuracy for liquids Down to 0.5 % mass flow accuracy for gases Down to 2 g/l (0.13 lb/ft³) accuracy for density Total Health Check (diagnostic function) Advanced functions: <ul style="list-style-type: none"> Standard concentration measurement Advanced concentration measurement Net Oil Computing following API standard Viscosity function Batching function Measurement of heat quantity Tube Health Check (diagnostic function) Features on Demand Communication: <ul style="list-style-type: none"> HART Modbus PROFIBUS PA Data backup on microSD card 	U
No transmitter	<ul style="list-style-type: none"> Spare sensor without transmitter, combinable with Rotamass Total Insight transmitter 	N

3 Application and measuring ranges

3.1 Measured quantities

The Rotamass Coriolis flow meter can be used to measure the following fluids:

- Liquids
- Gases
- Mixtures, such as emulsions, suspensions, slurries

Possible limitations applying to measurement of mixtures must be checked with the responsible Yokogawa sales organization.

The following variables can be measured using Rotamass:

- Mass flow
- Density
- Temperature

Based on these measured quantities, the transmitter also calculates:

- Volume flow
- Partial component concentration of a two-component mixture
- Partial component flow rate of a mixture consisting of two components (net flow)

In this process, the net flow is calculated based on the known partial component concentration and the overall flow.

3.2 Measuring range overview

	Giga 1F	Giga 2H	
Mass flow range			
Typical connection size	DN100, 4"	DN150, 6"	
Q_{nom}	250 t/h (9200 lb/min)	500 t/h (18000 lb/min)	[▶ 14]
Q_{max}	300 t/h (11000 lb/min)	600 t/h (22000 lb/min)	
Maximum volume flow			
(Water)	300 m ³ /h (2500 barrel/h)	600 m ³ /h (5000 barrel/h)	[▶ 14]
Range of fluid density			
	0 – 2 kg/l (0 – 125 lb/ft ³)		[▶ 14]
Process fluid temperature range			
Standard ¹⁾	-70 – 150 °C (-94 – 302 °F)		
Mid-range	-70 – 230 °C (-94 – 446 °F)		[▶ 26]
High	0 – 350 °C (32 – 662 °F)		

¹⁾ May be further restricted depending on the design.

Q_{nom} - Nominal mass flow

Q_{max} - Maximum mass flow

The nominal mass flow Q_{nom} is defined as the mass flow of water (temperature: 20 °C) at 1 bar (14.5 psi) pressure loss across the flow meter.

3.3 Mass flow

For Rotamass Giga the following meter sizes to be determined using the *Model code* [▶ 103] are available.

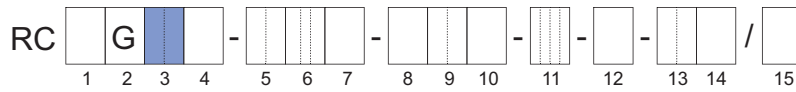

Mass flow of liquids

Meter size	Typical connection size	Q _{nom} in t/h (lb/min)	Q _{max} in t/h (lb/min)	Model code position 3
Giga 1F	DN100, 4"	250 (9200)	300 (11000)	1F
Giga 2H	DN150, 6"	500 (18000)	600 (22000)	2H

Mass flow of gases

When using Rotamass for measuring the flow of gases, the mass flow is usually limited by the pressure loss generated and the maximum flow velocity.

Type of gas	Maximum flow velocity
Oxygen	60 m/s
Methane	40 m/s
Natural gas	40 m/s
Other gases	33 % of sound velocity

3.4 Volume flow

Volume flow of liquids (water at 20 °C)

Meter size	Volume flow (at 1 bar pressure loss) in m ³ /h (barrel/h)	Maximum volume flow in m ³ /h (barrel/h)
Giga 1F	250 (2100)	300 (2500)
Giga 2H	500 (4200)	600 (5000)

Volume flow of gases

When using Rotamass for measuring the flow of gases, the flow rate is usually limited by the pressure loss generated and the maximum flow velocity.

Type of gas	Maximum flow velocity
Oxygen	60 m/s
Methane	40 m/s
Natural gas	40 m/s
Other gases	33 % of sound velocity

3.5 Pressure loss

The pressure loss along the flow meter is heavily dependent on the application. The pressure loss of 1 bar at nominal mass flow Q_{nom} also applies to water and is considered the reference value.

3.6 Density

Meter size	Measuring range of density
Giga 1F	0 – 2 kg/l (0 – 125 lb/ft ³)
Giga 2H	

Rather than being measured directly, density of gas is usually calculated using its reference density, process fluid temperature and process pressure.

3.7 Temperature

The process fluid temperature measuring range is limited by:

- Design type (integral or remote)
- Process connection size and type
- Ex approvals

Maximum measuring range: -70 – 350 °C (-94 – 662 °F)

4 Accuracy

In this chapter, maximum deviations are indicated as absolute values.



All accuracy data are given in \pm values.

4.1 Overview

Achievable accuracies for liquids

Maximum deviation D is made up of zero point stability Z and accuracy D_0 , see *Mass flow accuracy* [▶ 17]. The accuracy achieved at calibration conditions as delivered is specified below; see *Calibration conditions* [▶ 22].

Measured quantity		Accuracy for transmitters	
		Essential	Ultimate
Mass flow ¹⁾	Accuracy ²⁾ D_0	0.2 % of measured value	0.1 % of measured value
	Repeatability ³⁾	0.1 % of measured value	0.05 % of measured value
Volume flow (water) ¹⁾	Accuracy ²⁾ D_V	0.45 % of measured value	0.12 % of measured value
	Repeatability ³⁾	0.23 % of measured value	0.06 % of measured value
Density	Accuracy ²⁾	4 g/l (0.25 lb/ft ³)	2 g/l (0.13 lb/ft ³)
	Repeatability ³⁾	2 g/l (0.13 lb/ft ³)	1 g/l (0.06 lb/ft ³)
Temperature	Accuracy ²⁾	0.5 °C (0.9 °F)	0.5 °C (0.9 °F)

¹⁾ Based on the measured values of the pulse output. This means that the flow accuracy and repeatability considers the combined measurement uncertainties including sensor, electronic and pulse output interface.

²⁾ Best accuracy per transmitter type.

³⁾ The stated repeatability is included in the accuracy.

Achievable accuracies for gases

Measured quantity		Accuracy for transmitters	
		Essential	Ultimate
Mass flow / standard volume flow ¹⁾	Accuracy ²⁾ D_0	0.75 % of measured value	0.5 % of measured value
	Repeatability ³⁾	0.6 % of measured value	0.4 % of measured value
Temperature	Accuracy ²⁾	0.5 °C (0.9 °F)	0.5 °C (0.9 °F)

¹⁾ Based on the measured values of the pulse output. This means that the flow accuracy and repeatability considers the combined measurement uncertainties including sensor, electronic and pulse output interface.

²⁾ Best mass flow accuracy per transmitter type.

³⁾ The stated repeatability is included in the accuracy.

4.2 Zero point stability of the mass flow

In case of no flow, the maximum measured flow rate is called *Zero point stability*. Zero point values are shown in the table below.

Meter size	Zero point stability Z in kg/h (lb/h)
Giga 1F	13 (29)
Giga 2H	25 (55)

4.3 Mass flow accuracy

Maximum deviation D is made up of zero point stability Z and accuracy D_0 , resulting in the following formula:

$$D = \frac{Z}{Q} \times 100 \% + D_0$$

D^1	Maximum deviation in %	Q	Mass flow in kg/h
D_0	Accuracy	Z	Zero point stability

¹⁾ The repeatability is always 50 % of D and is included in the accuracy.

Basic accuracy depends on the product version selected and can be found in the tables in chapter *Accuracy of mass flow and density according to the model code* [▶ 19].

4.3.1 Sample calculation for liquids

Example

RC U G 1 F S - 1 Q B J 2 0 - 0 C 5 B - N N 0 0 - 2 - J D 1 /

1 2 3 4 5 6 7 8 9 10 11 12 13 14 15

Fluid:	Liquid
Zero point stability Z :	13 kg/h
Accuracy D_0 :	0.1 %
Value of mass flow Q :	6250 kg/h

Calculation of accuracy:

$$D = 13 \text{ kg/h} / 6250 \text{ kg/h} \times 100 \% + 0.1 \%$$

$$D = 0.31 \%$$

4.3.2 Sample calculation for gases

The maximum deviation in the case of gases depends on the product version selected, see also *Mass flow and density accuracy* [▶ 106].

Example

RC U G 1 F S - 1 Q B J 2 0 - 0 5 0 B - N N 0 0 - 2 - J D 1 /

1 2 3 4 5 6 7 8 9 10 11 12 13 14 15

Fluid:	Gas
Zero point stability Z :	13 kg/h
Accuracy D_0 :	0.5 %
Value of mass flow Q :	2500 kg/h

Calculation of accuracy:

$$D = 13 \text{ kg/h} / 2500 \text{ kg/h} \times 100 \% + 0.5 \%$$

$$D = 1.02 \%$$

4.4 Accuracy of density

4.4.1 For liquids

Meter size	Transmitter	Maximum deviation of density ¹⁾ in g/l (lb/ft ³)
Giga 1F	Essential	Down to 4 (0.25)
Giga 2H		
Giga 1F	Ultimate	Down to 2 (0.13)
Giga 2H		

¹⁾ Deviations possible depending on product version (meter size, type of calibration)

The maximum deviation depends on the product version selected, see also *Accuracy of mass flow and density according to the model code* [▶ 19].

4.4.2 For gases

In most applications, density at standard conditions is fed into the transmitter and used to calculate the standard volume flow based on mass flow.

If gas pressure is a known value, after entering a reference density, the transmitter is able to calculate gas density from temperature and pressure as well (while assuming an ideal gas).

Alternatively, there is an option for measuring gas density. In order to do so, it is necessary to adapt the lower density limit value in the transmitter.

For most applications the direct measurement of the gas density will have insufficient accuracy.

4.5 Accuracy of mass flow and density according to the model code

Accuracy for flow rate as well as density is selected via model code position 9. Here a distinction is made between devices for measuring liquids and devices for measuring gases. No accuracy for density measurement is specified for gas measurement devices.

4.5.1 For liquids

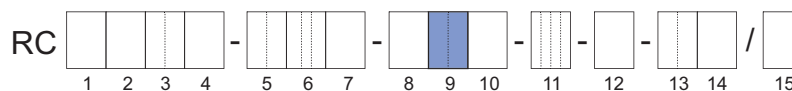

Essential

Model code position 9	Maximum deviation of density ¹⁾ in g/l	Applicable measuring range of accuracy in kg/l	Maximum deviation D_0 for mass flow in %	
			Giga 1F	Giga 2H
E7	4	0.3 – 2	0.2	0.2

¹⁾ Specified maximum deviation is achieved within the applicable measuring range for density.

Ultimate

Model code position 9	Maximum deviation of density ¹⁾ in g/l	Applicable measuring range of accuracy in kg/l	Maximum deviation D_0 for mass flow in %	
			Giga 1F	Giga 2H
E7	4	0.3 – 2	0.2	0.2
C5 ²⁾	2	0.3 – 2	0.1	0.1

¹⁾ Specified maximum deviation is achieved within the applicable measuring range for density.

²⁾ Notice: In case of a spare sensor combined with a transmitter in use, the original accuracy specification may be affected. For calibration services, please contact Yokogawa Service department.

4.5.2 For gases

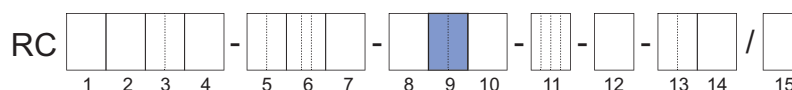

Essential

Model code position 9	Maximum accuracy D_0 for mass flow in %
70	0.75

Ultimate

Model code position 9	Maximum accuracy D_0 for mass flow in %
50 ¹⁾	0.5

¹⁾ Notice: In case of a spare sensor combined with a transmitter in use, the original accuracy specification may be affected. For calibration services, please contact Yokogawa Service department.

4.6 Volume flow accuracy

4.6.1 For liquids

The following formula can be used to calculate the accuracy of liquid volume flow:

$$D_V = \sqrt{D^2 + \left(\frac{\Delta\rho}{\rho} \times 100\%\right)^2}$$

D_V	Maximum deviation of volume flow in %
$\Delta\rho$	Maximum deviation of density in kg/l
D	Maximum deviation of mass flow in %
ρ	Density in kg/l

4.6.2 For gases

Accuracy of standard volume flow for gas with a fixed composition equals the maximum deviation D of the mass flow.

$$D_V = D$$



In order to determine the standard volume flow for gas, it is necessary to input a reference density in the transmitter. The accuracy specified is achieved only for fixed gas composites. Major deviations may appear if the gas composition changes.

4.7 Accuracy of temperature

Various process fluid temperature ranges are specified for Rotamass Giga:

- *Standard:*
 - Integral type: -50 – 150 °C (-58 – 302 °F)
 - Remote type: -70 – 150 °C (-94 – 302 °F)
- *Mid-range:*
 - Remote type: -70 – 230 °C (-94 – 446 °F)
- *High:*
 - Remote type: 0 – 350 °C (32 – 662 °F)

Accuracy of temperature depends on the sensor temperature range selected (see *Process fluid temperature range* [▶ 26]) and can be calculated as follows:

Formula for temperature specifications *Standard* and *Mid-range*

$$\Delta T = 0.5 \text{ °C} + 0.005 \times |T_{pro} - 20 \text{ °C}|$$

ΔT	Maximum deviation of temperature
T_{pro}	Process fluid temperature in °C

Formula for temperature specification *High*

$$\Delta T = 1.0 \text{ °C} + 0.008 \times |T_{pro} - 20 \text{ °C}|$$

ΔT	Maximum deviation of temperature
T_{pro}	Process fluid temperature in °C

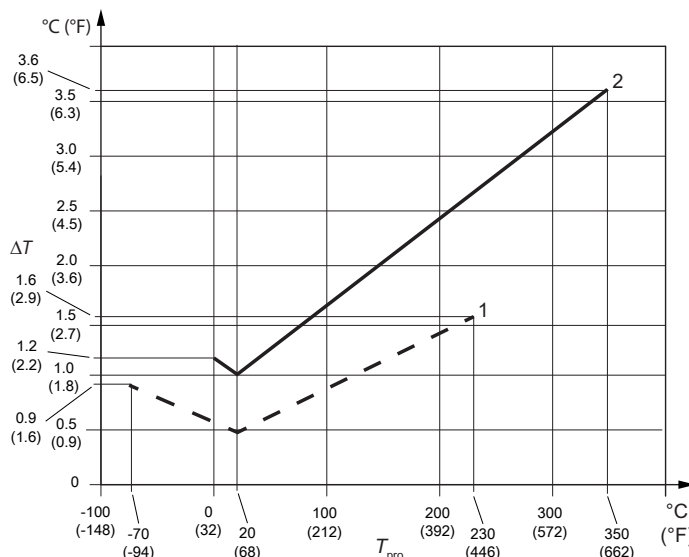

Fig. 10: Presentation of temperature accuracy

- 1 Temperature specification Standard and Mid-range
- 2 Temperature specifications High

Example

RC U G 1 F S - 1 Q B J 2 0 - 0 C 5 B - N N 0 0 - 2 - J D 1 /

The sample model code specifies the Standard temperature range.

Process fluid temperature T_{pro}: 50 °C

Calculation of accuracy:

$$\Delta T = 0.5 \text{ °C} + 0.005 \times |50 \text{ °C} - 20 \text{ °C}|$$

$$\Delta T = 0.65 \text{ °C}$$

4.8 Repeatability

For liquids

When using default damping times, the specified repeatability of mass flow, density and temperature measurements equals half of the respective maximum deviation.

$$R = \frac{D}{2}$$

- R Repeatability
- D Maximum deviation

For gases

In deviation hereto, the following applies to mass and standard volume flow of gases:

$$R = \frac{D}{1.25}$$

4.9 Calibration conditions

4.9.1 Mass flow calibration and density adjustment

All Rotamass are calibrated in accordance with the state of the art at Rota Yokogawa. Optionally, the calibration can be performed according to a method accredited by DAkkS in accordance with DIN EN ISO/IEC 17025 (Option K5, see *Certificates* [▶ 115]).

Each Rotamass device comes with a standard calibration certificate.

Calibration takes place at reference conditions. Specific values are listed in the standard calibration certificate.

	Reference conditions
Fluid	Water
Density	0.9 – 1.1 kg/l (56 – 69 lb/ft ³)
Fluid temperature	10 – 35 °C (50 – 95 °F) Average temperature: 22.5 °C (72.5 °F)
Ambient temperature	10 – 35 °C (50 – 95 °F)
Process pressure (absolute)	1 – 2 bar (15 – 29 psi)

The accuracy specified is achieved at as-delivered calibration conditions stated.

4.10 Process pressure effect

Process pressure effect is defined as the change in sensor flow and density deviation due to process pressure change away from the calibration pressure. This effect can be corrected by dynamic pressure input or a fixed process pressure.

Tab. 1: Process pressure effect, wetted parts stainless steel 1.4404/ 316L and Ni alloy C-22/ 2.4602

Meter size	Material	Deviation of Flow		Deviation of Density	
		in % of rate per bar	in % of rate per psi	in g/l per bar	in g/l per psi
Giga 1F	1.4404/316L	-0.0289	-0.00199	-0.140	-0.0097
	C-22/2.4602	-0.0313	-0.00216	-0.191	-0.0132
Giga 2H	1.4404/316L	-0.0484	-0.00334	-0.179	-0.0123

4.11 Process fluid temperature effect

For mass flow and density measurement, process fluid temperature effect is defined as the change in sensor flow and density accuracy due to process fluid temperature change away from the calibration temperature. For temperature ranges, see *Process fluid temperature range* [▶ 26].

Temperature effect on Zero

Temperature effect on Zero of mass flow can be corrected by zeroing at the process fluid temperature.

Temperature effect on mass flow

The process fluid temperature is measured and the temperature effect compensated. However due to uncertainties in the compensation coefficients and in the temperature measurement an uncertainty of this compensation is left. The typical rest error of Rotamass Total Insight temperature effect on mass flow is:

Tab. 2: All models

Temperature range	Uncertainty of flow
Standard, Mid-range	±0.001 % of rate / °C (±0.0005 % of rate / °F)
High	±0.0011 % of rate / °C (±0.0006 % of rate / °F)

The temperature used for calculation of the uncertainty is the difference between process fluid temperature and the temperature at calibration condition. For temperature ranges, see *Process fluid temperature range* [▶ 26].

Temperature effect on density measurement (liquids)

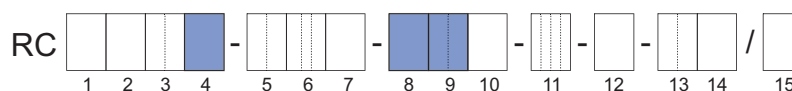

Process fluid temperature influence:

Formula for metric values

$$D'_{\rho} = \pm k \times \text{abs}(T_{\text{pro}} - 20 \text{ }^{\circ}\text{C})$$

Formula for imperial values

$$D'_{\rho} = \pm k \times \text{abs}(T_{\text{pro}} - 68 \text{ }^{\circ}\text{F})$$

D'_{ρ} Additional density deviation due to the effect of fluid temperature in g/l (lb/ft³)

T_{pro} Process fluid temperature in °C (°F)

k Constant for temperature effect on density measurement in g/l × 1/°C (lb/ft³ × 1/°F)

Tab. 3: Constants for particular meter size and model code position (see also *Process fluid temperature range* [▶ 26] and *Mass flow and density accuracy* [▶ 106])

Meter size	Model code position 4	Model code position 8	Model code position 9	k in g/l × 1/°C (lb/ft ³ × 1/°F)
Giga 1F	S	0, 2	C5, E7	0.110 (0.0038)
		3		0.290 (0.0101)
	H	0, 2	C5, E7	0.090 (0.0031)
		3		0.210 (0.0073)
Giga 2H	S	0, 2	C5, E7	0.070 (0.0024)
		3		0.180 (0.0062)

5 Operating conditions

5.1 Location and position of installation

Rotamass Coriolis flow meters can be mounted horizontally, vertically and at an incline. The measuring tubes should be completely filled with the fluid during flow measurement as accumulations of air or formation of gas bubbles in the measuring tube may result in errors in measurement. Straight pipe runs at inlet or outlet are usually not required.

Avoid the following installation locations and positions:

- Measuring tubes as highest point in piping when measuring liquids
- Measuring tubes as lowest point in piping when measuring gases
- Immediately in front of a free pipe outlet in a downpipe
- Lateral positions

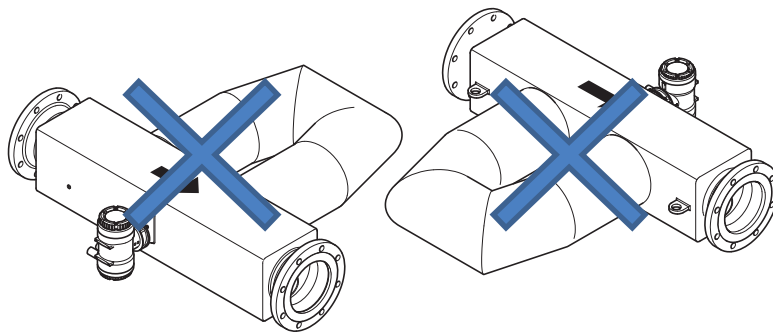
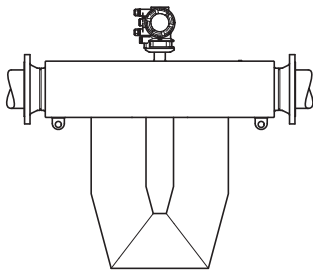
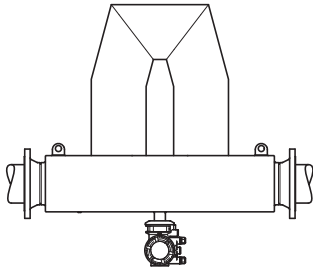
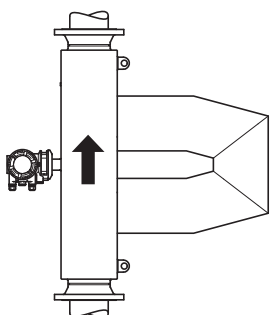

Fig. 11: Installation position to be avoided: Flow meter in sideways position

5.1.1 Sensor installation position

Sensor installation position as a function of the fluid

Installation position	Fluid	Description
Horizontal, measuring tubes at bottom 	Liquid	The measuring tubes are oriented toward the bottom. Accumulation of gas bubbles is avoided.
Horizontal, measuring tubes at top 	Gas	The measuring tubes are oriented toward the top. Accumulation of liquid, such as condensate is avoided.

Installation position	Fluid	Description
Vertical, direction of flow towards the top (recommended) 	Liquid/gas	The sensor is installed on a pipe with the direction of flow towards the top. Accumulation of gas bubbles or solids is avoided. This position allows for complete self-draining of the measuring tubes.

5.2 Installation instructions

The following instructions for installation must be observed:

1. Protect the flow meter from direct solar irradiation in order to avoid exceeding the maximum allowed temperature of the transmitter.
2. In case of installing two sensors of the same kind back-to-back redundantly, use a customized design and contact the responsible Yokogawa sales organization.
3. Avoid installation locations susceptible to cavitation, such as immediately behind a control valve.
4. In case that the fluid temperatures deviate approx. 80 °C from the ambient temperature, insulating the sensor is recommended in order to avoid injuries as well as to maintain utmost accuracy, see *Insulation and heat tracing* [▶ 30].
5. Avoid installation directly behind rotary and gear pumps to prevent fluctuations in pressure from interfering with the resonance frequency of the Rotamass measuring tubes.
6. In case of remote installation: When installing the connecting cable between sensor and transmitter, keep the cable temperature above -10 °C (14 °F) to prevent cable damage from the installation stresses.

5.3 Process conditions



The pressure and temperature ratings presented in this section represent the design values for the devices. For individual applications (e.g. marine applications with option MC_) further limitations may apply according to the respective applicable regulations. For details see chapter *Marine approval* [▶ 119].

5.3.1 Process fluid temperature range



Allowed process fluid and ambient temperature ranges in hazardous areas depend on classifications defined by applications, refer to *Temperature specification in hazardous areas* [▶ 35].

For Rotamass Giga the following process fluid temperature ranges are available:

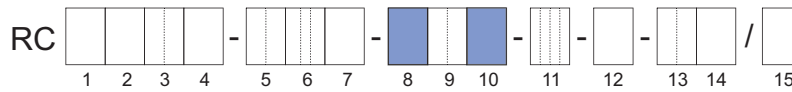

Temperature range	Model code position 8	Process fluid temperature in °C (°F)	Design type	Model code position 10
Standard	0	-50 – 150 (-58 – 302)	Integral type	0, 2
		-70 – 150 (-94 – 302)	Remote type	A, B, E, F, J, K
Mid-range	2	-70 – 230 (-94 – 446)		B, F, K
High	3	0 – 350 (32 – 662)		B, F, K

5.3.2 Density

Meter size	Measuring range of density
Giga 1F	0 – 2 kg/l (0 – 125 lb/ft³)
Giga 2H	

Rather than being measured directly, density of gas is usually calculated using its reference density, process fluid temperature and process pressure.

5.3.3 Pressure

The maximum allowed process pressure depends on the selected process connection and its surface temperature.

The given process connection temperature and process pressure ranges are calculated and approved without corrosion or erosion effects.

The following diagrams shows the process pressure as a function of process connection temperature as well as the process connection used (type and size of process connection).

**ASME class 150
EN PN16**

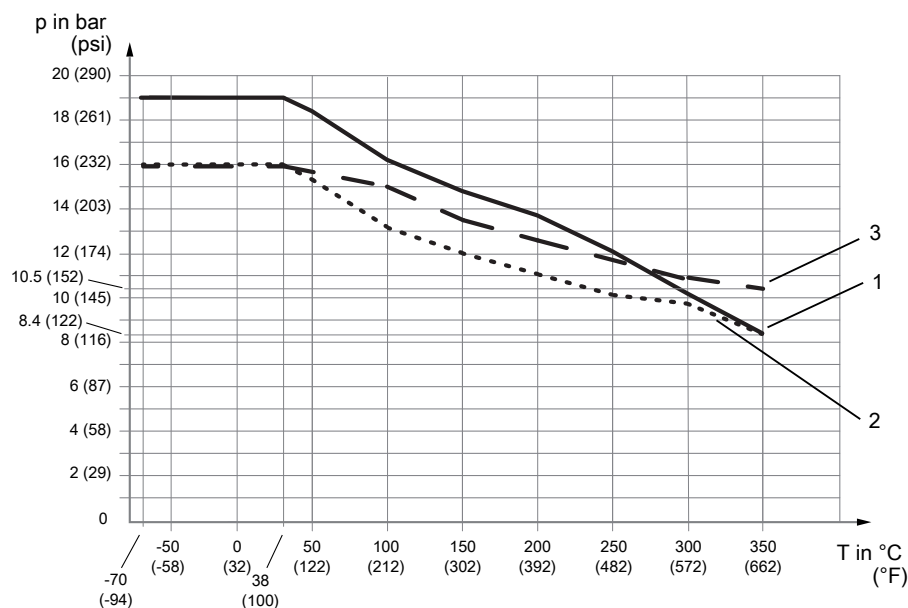

Fig. 12: Allowed process pressure as a function of process connection temperature

- 1 Process connection suitable for ASME B16.5 class 150
- 2 Heat tracing connection suitable for ASME B16.5 class 150
- 3 Process connection suitable for EN 1092-1 PN16

**ASME class 300
EN PN40**

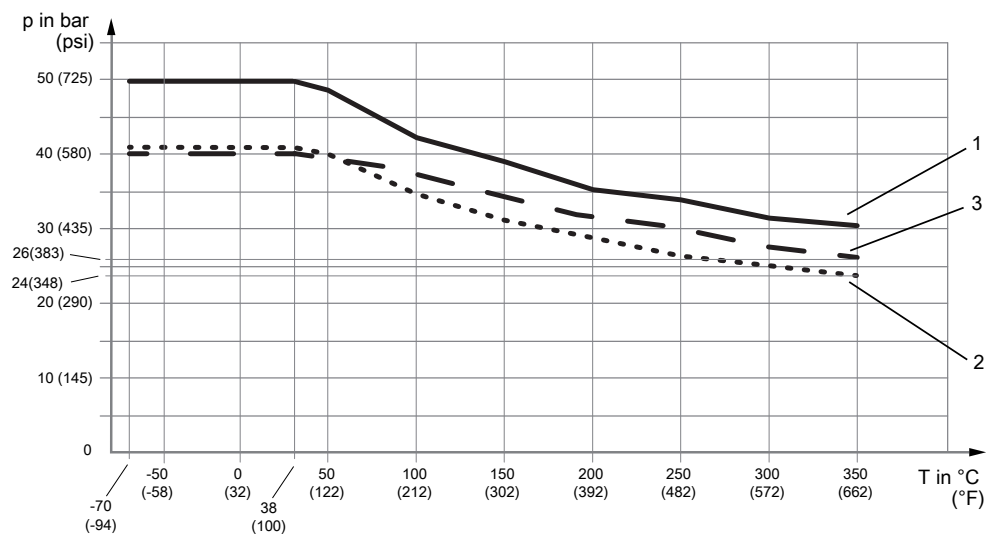

Fig. 13: Allowed process pressure as a function of process connection temperature

- 1 Process connection suitable for ASME B16.5 class 300
- 2 Heat tracing connection for ASME B16.5 class 300
- 3 Process and heat tracing connection suitable for EN 1092-1 PN40

**ASME class 600
EN PN63**

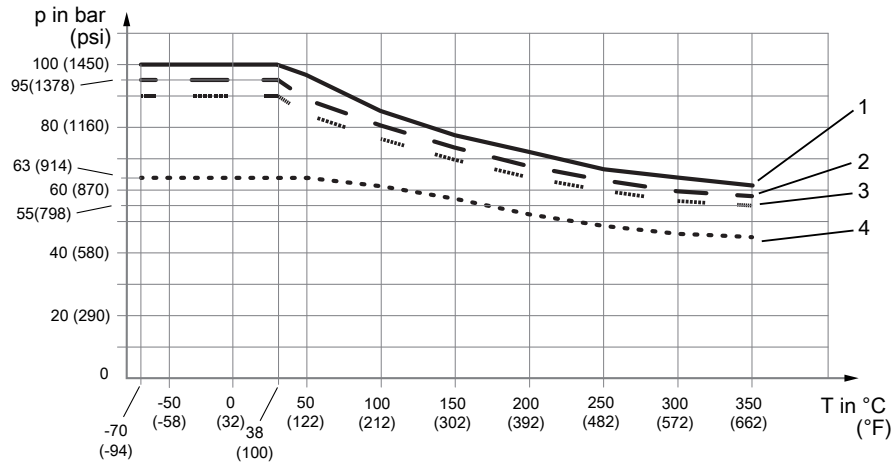

Fig. 14: Allowed process pressure as a function of process connection temperature

- 1 Process connection suitable for ASME B16.5 class 600:
Giga with meter size 1F, material wetted parts S or H (without ASME compliance);
Giga with meter size 1F, material wetted parts H and ASME compliance (option P15)
- 2 Process connection suitable for ASME B16.5 class 600:
Giga with meter size 1F, material wetted parts S and ASME compliance (option P15)
- 3 Process connection suitable for ASME B16.5 class 600:
Giga with meter size 2H
- 4 Process connection suitable for EN 1092-1 PN63

EN PN100

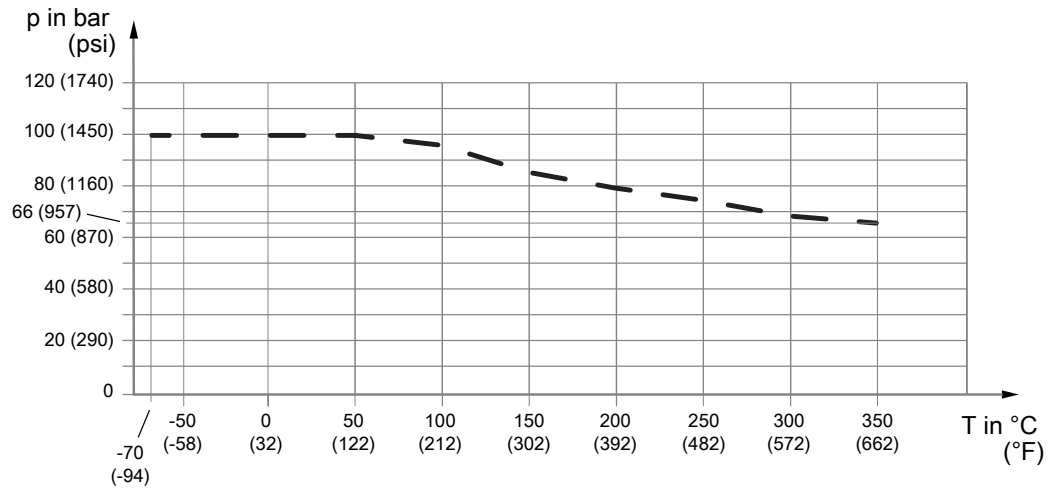

Fig. 15: Allowed process pressure as a function of process connection temperature, suitable for flange EN 1092-1 PN100

JIS 10K
JIS 20K

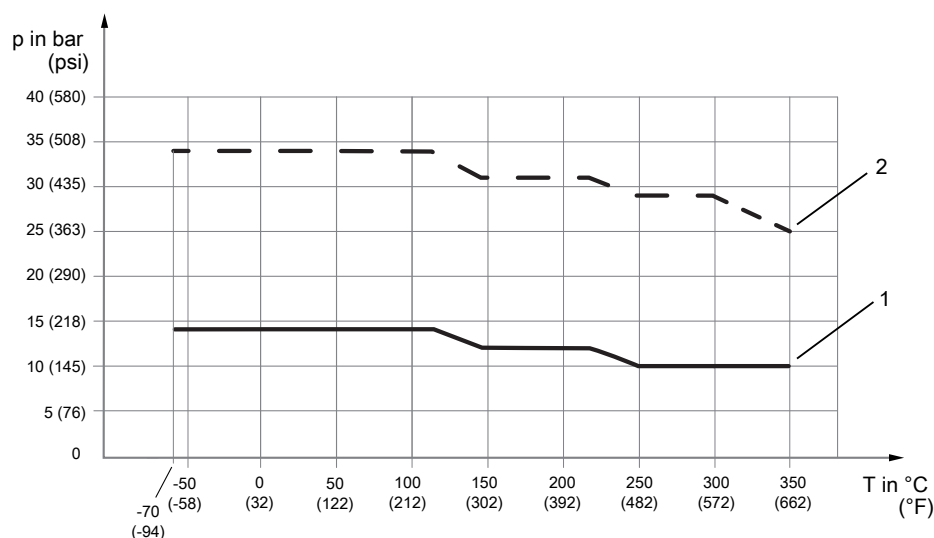

Fig. 16: Allowed process pressure as a function of process connection temperature

- 1 Process connection suitable for JIS B 2220 10K
- 2 Process connection suitable for JIS B 2220 20K

Rupture disc

The rupture disc is located on the sensor housing. It is available as an option, see *rupture disc* [▶ 117]. The rupture disc's bursting pressure is 20 bar. In the case of big nominal diameters and high pressures, it is not possible to ensure that the entire process pressure is released across the rupture disc. In the event this is necessary, it is possible to request a customized design from the responsible Yokogawa sales organization. In the event of a burst pipe, the rupture disc provides an acoustic signal in applications with gases.

5.3.4 Mass flow

For **liquids** the preferred measuring range is 10 % - 80 % of Q_{nom} , see *Mass flow* [▶ 14].

For **gases**, as a result of low gas density, the maximum mass flow Q_{max} is usually not reached in gas measurements. In general, the maximum flow velocity should not exceed 33 % of the sound velocity of the fluid, see *Mass flow* [▶ 14].

5.3.5 Insulation and heat tracing



In case that the fluid temperature deviates more than 80 °C (176 °F) from the ambient temperature, insulating the sensor is recommended to avoid negative effects from temperature fluctuations on accuracy.

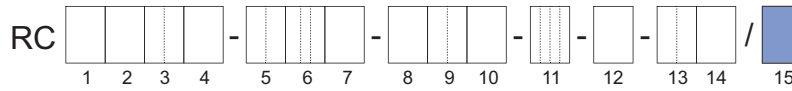

Overview of device options for insulation and heat tracing for remote type

Options	Description
T10	<ul style="list-style-type: none"> Insulation
T21, T22, T26	<ul style="list-style-type: none"> Insulation Heat tracing without ventilation
T31, T32, T36	<ul style="list-style-type: none"> Insulation Heat tracing with ventilation

For details about the ordering information see chapter under the same heading *Insulation and heat tracing* [▶ 114] in the model code description.

In case of subsequent sensor insulation installed by the customer, the following must be noted:

- Do not insulate transmitter as well.
- In case of remote type, do not insulate the terminal box of the sensor.
- Do not expose transmitters to ambient temperatures exceeding 60 °C (140 °F).
- The preferred insulation is 80 mm (3.15 inch) thick with a heat transfer coefficient of 0.4 W/m² K (0.07 Btu/ ft² °F).

Maximum temperature of heat carrier

Temperature range	Model code position 8	Maximum temperature range of heat carrier in °C (°F)
Standard	0	0 – 150 (32 – 302)
Mid-range	2	0 – 230 (32 – 446) ¹⁾
High	3	0 – 350 (32 – 662)

¹⁾ With Ex Approval 0 – 220 °C (32 – 428 °F)

Pressure ratings of heat tracing are defined based on heat tracing connection, refer to *Pressure* [▶ 26].

Subsequent installation of an electrical heat tracing to the sensor is possible. Electromagnetic insulation is required in case the heating device is controlled by phase-fired control or pulse train.



In hazardous areas, subsequent application of insulation, heating jacket or heating strips is not permitted.

5.3.6 Secondary containment

Some applications or environment conditions require secondary containment retaining the process pressure for increased safety. All Rotamass Total Insight have a secondary containment filled with inert gas. The burst pressure typical values of the secondary housing are defined in the table below.

Typical burst pressure at room temperature

Burst pressure in bar (psi)	
Giga 1F	Giga 2H
65 (942)	50 (725)

5.4 Ambient conditions

Rotamass Total Insight can be used at demanding ambient conditions.

In doing so, the following specifications must be taken into account:

The air surrounding the device is considered as ambient temperature.

Allowed ambient and storage temperature of Rotamass Total Insight depends on the below components and their own temperature limits:

- Sensor
- Transmitter
- Connecting cable between sensor and transmitter (for remote design type)

Ambient temperature

If the device is operating outdoors make sure that the solar irradiation does not increase the surface temperature of the device higher than the allowed maximum ambient temperature. Transmitter display has limited legibility below -20 °C (-4 °F).

Maximum ambient temperature range		
integral type:		-40 – 60 °C (-40 – 140 °F)
remote type		
with standard cable (option L _{...}):	Sensor ¹⁾ :	-50 – 80 °C (-58 – 176 °F)
	Transmitter:	-40 – 60 °C (-40 – 140 °F)
with fire retardant cable ²⁾ (option Y _{...}):	Sensor ¹⁾ :	-35 – 80 °C (-31 – 176 °F)
	Transmitter:	-35 – 60 °C (-31 – 140 °F)

¹⁾ Check derating for high fluid temperature, see *Process fluid temperature range* [▶ 26], *Process conditions* [▶ 26] and *Allowed ambient temperature for sensor* [▶ 32]

²⁾ Lower temperature specification valid for fixed installation only

Storage temperature

Maximum storage temperature range		
integral type		-40 – 60 °C (-40 – 140 °F)
remote type		
with standard cable (option L _{...}):	Sensor:	-50 – 80 °C (-58 – 176 °F)
	Transmitter:	-40 – 60 °C (-40 – 140 °F)
with fire retardant cable (option Y _{...}):	Sensor:	-35 – 80 °C (-31 – 176 °F)
	Transmitter:	-35 – 60 °C (-31 – 140 °F)

Further ambient conditions

Ranges and specifications	
Relative humidity	0 – 95 %
IP code	IP66/67 for transmitters and sensors when using the appropriate cable glands
Allowable pollution degree in surrounding area acc.: EN 61010-1	4 (in operation)
Resistance to vibration acc.: IEC 60068-2-6 (not with option T _{...})	Transmitter: 10 – 500 Hz, 1g Sensor: 25 – 100 Hz, 4g

Ranges and specifications	
Electromagnetic compatibility (EMC) <ul style="list-style-type: none"> ▪ IEC/EN 61326-1, Table 2 ▪ IEC/EN 61326-2-3 ▪ NAMUR NE 21 recommendation ▪ DNVGL-CG-0339, chapter 14 This includes <ul style="list-style-type: none"> ▪ Surge immunity acc.: <ul style="list-style-type: none"> – EN 61000-4-5 for lightning protection ▪ Emission acc.: <ul style="list-style-type: none"> – IEC/EN 61000-3-2, Class A – IEC/EN 61000-3-3, Class A – NAMUR NE 21 recommendation – DNVGL-CG-0339, chapter 14 	Immunity assessment criterion: The output signal fluctuation is within $\pm 1\%$ of the output span.
Maximum altitude	2000 m (6600 ft) above mean sea level (MSL)
Overvoltage category according to IEC/EN 61010-1	II

5.4.1 Allowed ambient temperature for sensor

The allowed ambient temperature of the sensor depends on the following product properties:

- Process fluid temperature, see *Process fluid temperature range* [▶ 26]
- Design type
 - Integral type
 - Remote type
- Connecting cable type (options L_{....} and Y_{....})

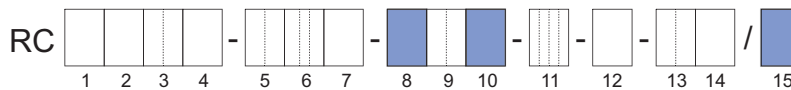

The allowed combinations of process fluid and ambient temperature for the sensor are illustrated as gray areas in the diagrams below.



Allowed process fluid and ambient temperature ranges in hazardous areas depend on classifications defined by applications, refer to *Temperature specification in hazardous areas* [▶ 35].

Temperature specification Standard, integral type

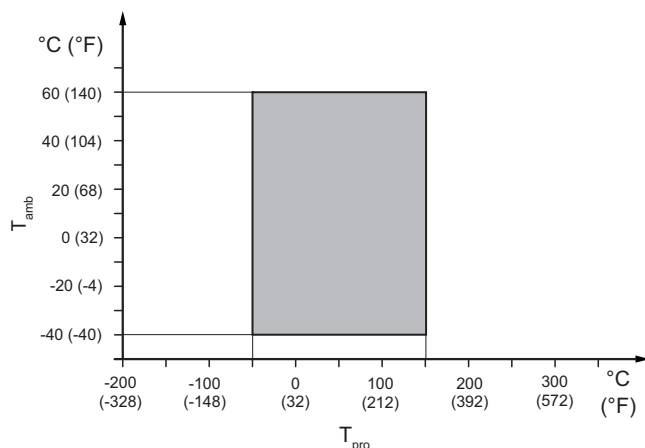

Fig. 17: Allowed fluid and ambient temperatures, integral type

T_{amb} Ambient temperature
 T_{pro} Process fluid temperature

Temperature specification Standard, remote type

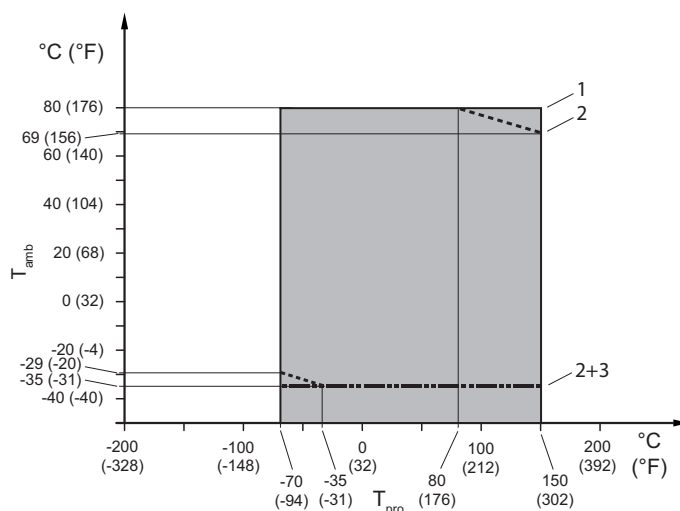

Fig. 18: Allowed process fluid and ambient temperatures, remote type

- 1 Standard cable option L_{_____}
- 2 Limitation for fire retardant cable option Y_{_____} for standard neck or long neck with option T_{__}
- 3 Limitation for fire retardant cable option Y_{_____} for long neck without option T_{__}

**Temperature specification
Mid-range,
remote type**

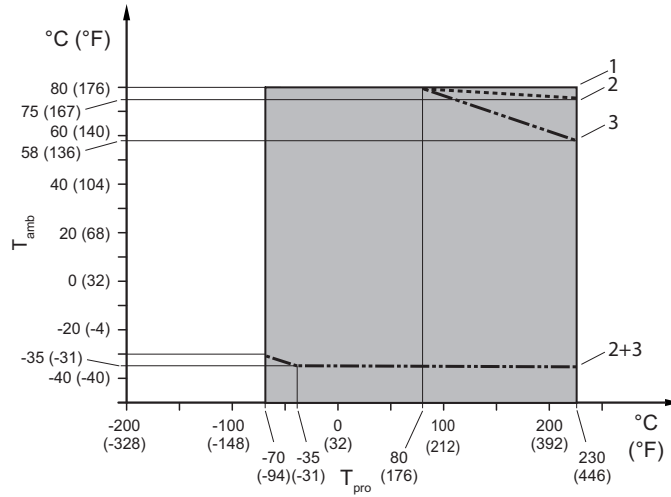

Fig. 19: Allowed process fluid and ambient temperatures, remote type

- 1 Standard cable option L_ _ _
- 2 Limitation for fire retardant cable option Y_ _ _ without option T_ _
- 3 Limitation for fire retardant cable option Y_ _ _ with option T_ _

**Temperature specification
High-range,
remote type**

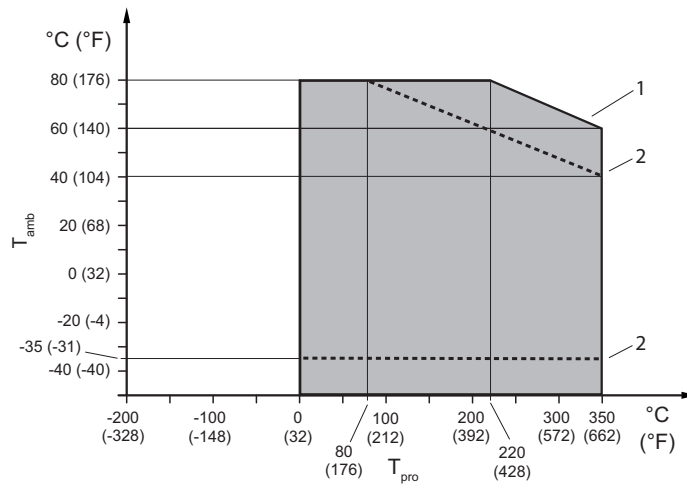

Fig. 20: Allowed process fluid and ambient temperatures, remote type

- 1 Standard cable option L_ _ _
- 2 Limitation for fire retardant cable option Y_ _ _

5.4.2 Temperature specification in hazardous areas

The maximum ambient and process fluid temperatures of Integral type and Remote Sensor depending on explosion groups and temperature classes can be determined via the model code or via the model code together with the Ex code (see the corresponding Explosion Proof Type Manual).

Model code:

Pos. 2: G

Pos. 8: 0

Pos. 10: 0, 2

Pos. 11: _F21, FF11

Ex code:

7.89.89.90.54.10

The following figure shows the relevant positions of the model code:

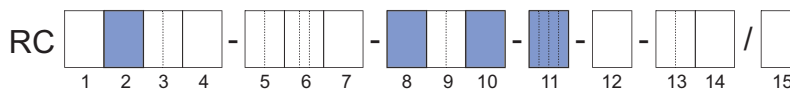

Tab. 4: Temperature classification

Temperature class	Maximum ambient temperature in °C (°F)	Maximum fluid temperature in °C (°F)
T6	39 (102)	70 (158)
T5	54 (129)	85 (185)
T4	60 (140)	121 (249)
T3	60 (140)	150 (302)
T2	60 (140)	150 (302)
T1	60 (140)	150 (302)

Model code:

Pos. 2: G

Pos. 8: 0

Pos. 10: 0, 2

Pos. 11: _F22, FF12

Ex code:

7.84.84.86.54.10

The following figure shows the relevant positions of the model code:

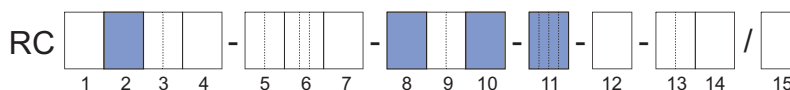

Tab. 5: Temperature classification

Temperature class	Maximum ambient temperature in °C (°F)	Maximum fluid temperature in °C (°F)
T6	41 (105)	65 (149)
T5	56 (132)	80 (176)
T4	60 (140)	117 (242)
T3	60 (140)	150 (302)
T2	60 (140)	150 (302)
T1	60 (140)	150 (302)

Model code:

Pos. 2: G

Pos. 8: 0

Pos. 10: 0, 2

Pos. 11: JF54, JF53

Ex code:

-

The following figure shows the relevant positions of the model code:

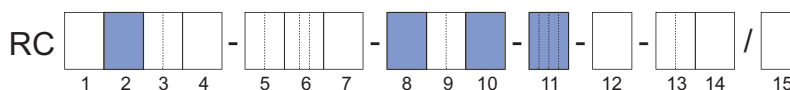

Tab. 6: Temperature classification

Temperature class	Maximum ambient temperature in °C	Maximum fluid temperature in °C
T4	60	121
T3	60	150

Model code:

Pos. 2: G

Pos. 8: 0

Pos. 10: A, E, J

Pos. 11: _F21, FF11

Ex code:

7.89.89.90.54.10

The following figure shows the relevant positions of the model code:

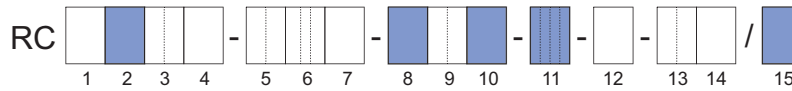

Tab. 7: Temperature classification

Temperature class	Maximum ambient temperature in °C (°F)		Maximum fluid temperature in °C (°F)
	Option L_	Option Y_	
T6	37 (98)	37 (98)	70 (158)
T5	52 (125)	52 (125)	85 (185)
T4	80 (176)	60 (140)	121 (249)
T3	78 (172)	49 (120)	150 (302)
T2	78 (172)	49 (120)	150 (302)
T1	78 (172)	49 (120)	150 (302)

Option Y_ not with model code pos. 11: FF11

Model code:

Pos. 2: G

Pos. 8: 0

Pos. 10: A, E, J

Pos. 11: _F22, FF12

Ex code:

7.84.84.86.54.10

The following figure shows the relevant positions of the model code:

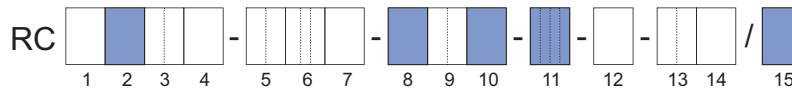

Tab. 8: Temperature classification

Temperature class	Maximum ambient temperature in °C (°F)		Maximum fluid temperature in °C (°F)
	Option L_	Option Y_	
T6	39 (102)	39 (102)	65 (149)
T5	54 (129)	54 (129)	80 (176)
T4	80 (176)	62 (143)	117 (242)
T3	78 (172)	49 (120)	150 (302)
T2	78 (172)	49 (120)	150 (302)
T1	78 (172)	49 (120)	150 (302)

Option Y_ not with model code pos. 11: FF12

Model code:

Pos. 2: G

Pos. 8: 0

Pos. 10: A, E

Pos. 11: JF54, JF53

Ex code:

-

The following figure shows the relevant positions of the model code:

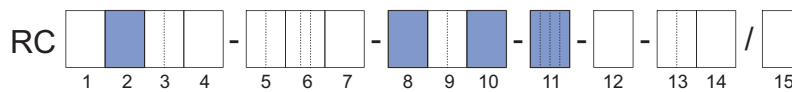

Tab. 9: Temperature classification

Temperature class	Maximum ambient temperature in °C		Maximum fluid temperature in °C
	Option L_	Option Y_	
T4	80	-	121
T3	78	-	150

Model code:**Pos. 2: G****Pos. 8: 0****Pos. 10: B, F, K****Pos. 11: _F21, FF11****Ex code:****7.89.89.90.54.10**

The following figure shows the relevant positions of the model code:

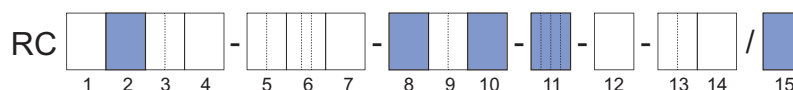

Tab. 10: Temperature classification

Temperature class	Maximum ambient temperature in °C (°F)		Maximum fluid temperature in °C (°F)
	Option L_	Option Y_	
T6	44 (111)	44 (111)	70 (158)
T5	59 (138)	59 (138)	85 (185)
T4	80 (176)	73 (163)	121 (249)
T3	80 (176)	70 (158)	150 (302)
T2	80 (176)	70 (158)	150 (302)
T1	80 (176)	70 (158)	150 (302)

Option Y_ not with model code pos. 11: FF11

Model code:**Pos. 2: G****Pos. 8: 0****Pos. 10: B, F, K****Pos. 11: _F22, FF12****Ex code:****7.84.84.86.54.10**

The following figure shows the relevant positions of the model code:

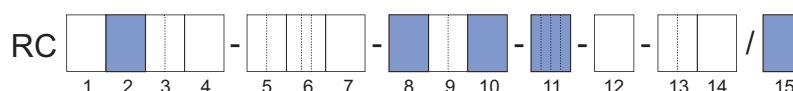

Tab. 11: Temperature classification

Temperature class	Maximum ambient temperature in °C (°F)		Maximum fluid temperature in °C (°F)
	Option L_	Option Y_	
T6	44 (111)	44 (111)	65 (149)
T5	59 (138)	59 (138)	80 (176)
T4	80 (176)	74 (165)	117 (242)
T3	80 (176)	70 (158)	150 (302)
T2	80 (176)	70 (158)	150 (302)
T1	80 (176)	70 (158)	150 (302)

Option Y_ not with model code pos. 11: FF12

Model code:**Pos. 2: G****Pos. 8: 0****Pos. 10: B, F****Pos. 11: JF54, JF53****Ex code:**

-

The following figure shows the relevant positions of the model code:

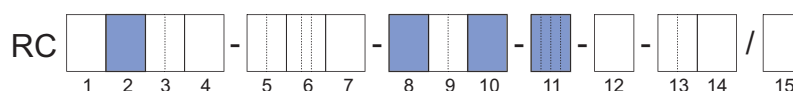

Tab. 12: Temperature classification

Temperature class	Maximum ambient temperature in °C		Maximum fluid temperature in °C
	Option L_	Option Y_	
T4	80	–	121
T3	78	–	150

Model code:

Pos. 2: G

Pos. 8: 2

Pos. 10: B, F, K

Pos. 11: _F21, FF11

Ex code:

7.89.89.90.90.80

The following figure shows the relevant positions of the model code:

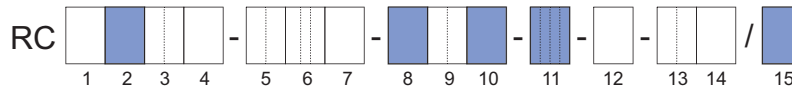

Tab. 13: Temperature classification

Temperature class	Maximum ambient temperature in °C (°F)		Maximum fluid temperature in °C (°F)
	Option L_	Option Y_	
T6	44 (111)	44 (111)	70 (158)
T5	59 (138)	59 (138)	85 (185)
T4	80 (176)	73 (163)	121 (249)
T3	80 (176)	64 (147)	186 (366)
T2	80 (176)	59 (138)	220 (428)
T1	80 (176)	59 (138)	220 (428)

Option Y_ not with model code pos. 11: FF11

Model code:

Pos. 2: G

Pos. 8: 2

Pos. 10: B, F, K

Pos. 11: _F22, FF12

Ex code:

7.84.84.86.87.80

The following figure shows the relevant positions of the model code:

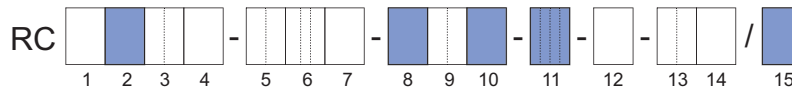

Tab. 14: Temperature classification

Temperature class	Maximum ambient temperature in °C (°F)		Maximum fluid temperature in °C (°F)
	Option L_	Option Y_	
T6	44 (111)	44 (111)	65 (149)
T5	59 (138)	59 (138)	80 (176)
T4	80 (176)	74 (165)	117 (242)
T3	80 (176)	64 (147)	183 (361)
T2	80 (176)	59 (138)	220 (428)
T1	80 (176)	59 (138)	220 (428)

Option Y_ not with model code pos. 11: FF12

Model code:

Pos. 2: G

Pos. 8: 2

Pos. 10: B, F

Pos. 11: JF52

Ex code:

-

The following figure shows the relevant positions of the model code:

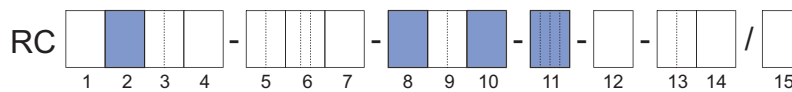

Tab. 15: Temperature classification

Temperature class	Maximum ambient temperature in °C		Maximum fluid temperature in °C
	Option L_	Option Y_	
T2	80	-	220

Model code:**Pos. 2: G****Pos. 8: 3****Pos. 10: B, F, K****Pos. 11: _F21, _F22,
FF11, FF12****Ex code:**

-

The following figure shows the relevant positions of the model code:

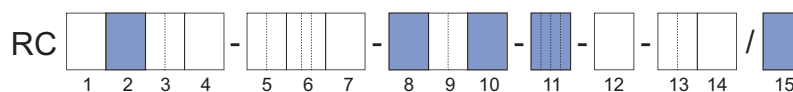

Tab. 16: Temperature classification

Temperature class	Maximum ambient temperature in °C (°F)		Maximum fluid temperature in °C (°F)
	Option L_	Option Y_	
T6	62 (143)	62 (143)	65 (149)
T5	77 (170)	77 (170)	80 (176)
T4	80 (176)	74 (165)	115 (239)
T3	80 (176)	65 (149)	180 (356)
T2	73 (163)	50 (122)	275 (527)
T1	60 (140)	40 (104)	350 (662)

Option Y_ not with model code pos. 11: FF11, FF12

6 Mechanical specification

6.1 Design

The Rotamass Giga flow meter is available with two design types:

- Integral type, sensor and transmitter are firmly connected
- Remote type
 - Standard neck
 - Long neck

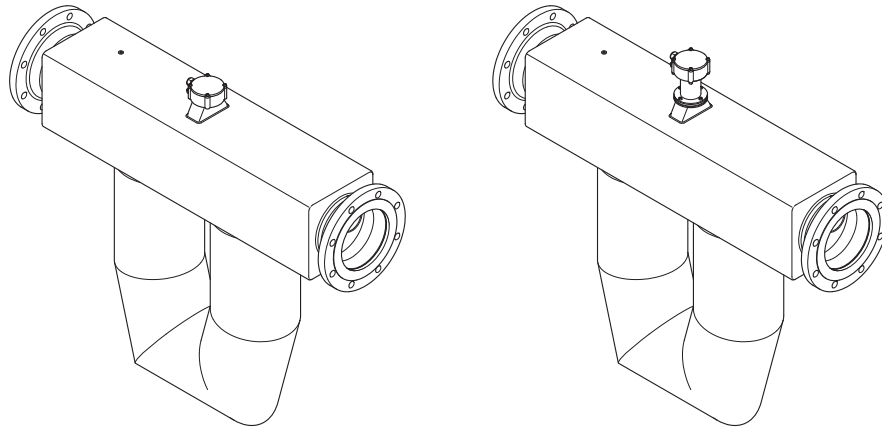
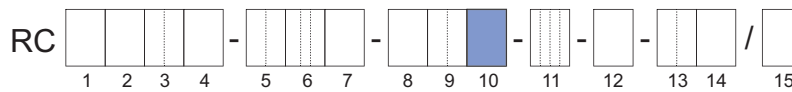

Fig. 21: Standard and long neck



Design type	Design version	Process fluid temperature range	Model code position 10
Integral type	Direct connection	Standard	0, 2
	Standard neck		A, E, J
Remote type	Long neck	Standard	B, F, K
		Mid-range	
High			



If insulation (e.g. device option / T_..) is planned, it is mandatory to use the remote type with long neck.



The design influences the temperature specification for Ex-approved Rotamass, see Explosion Proof Type Manual (IM 01U10X_..-00_..-R).

6.2 Material

6.2.1 Material wetted parts

The wetted parts of Rotamass Giga are available in two material versions.

For corrosive fluids, use of a corrosion-resistant nickel alloy (nickel alloy C-22/2.4602) is recommended for wetted parts.

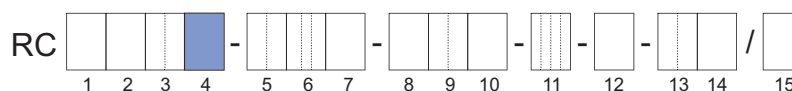

Material	Model code position 4
Stainless steel 1.4404/316L	S
Nickel alloy C-22/2.4602	H

6.2.2 Non-wetted parts

Housing material of sensor and transmitter are specified via model code position 7 and position 10.

Sensor housing material



Housing material	Model code position 7
Stainless steel 1.4301/304, 1.4404/316L	0
Stainless steel 1.4404/316L	1

Transmitter housing, coating and bracket material

The transmitter housing is available with different coatings:

- Standard coating
Urethane-cured polyester powder coating
- Corrosion protection coating
Three-layer coating with high chemical resistance (polyurethane coating on two layers of epoxy coating)

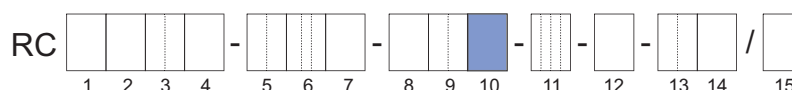

Housing material	Coating	Design type	Model code position 10	Bracket material
Aluminum Al-Si10Mg(Fe)	Standard coating	Integral type	0	–
		Remote type	A, B	Stainless steel 1.4404/316L
	Corrosion protection coating	Integral type	2	–
		Remote type	E, F	Stainless steel 1.4404/316L
Stainless steel CF8M	–	Remote type	J, K	Stainless steel 1.4404/316L
	–			

See also *Design and housing* [▶ 106].

Nameplate

For stainless steel transmitter the nameplates are made of stainless steel 1.4404/316L. Aluminum transmitter nameplates are made of foil.

In case of sensor housing material stainless steel 1.4404/316L (Model code position 7, value 1), nameplates of sensor are made of stainless steel 1.4404/316L. With other sensor housing material and with process fluid temperature range standard the sensor nameplates are made of foil, for other temperature ranges the nameplates are made of stainless steel 1.4404/316L.

6.3 Process connections, dimensions and weights of sensor

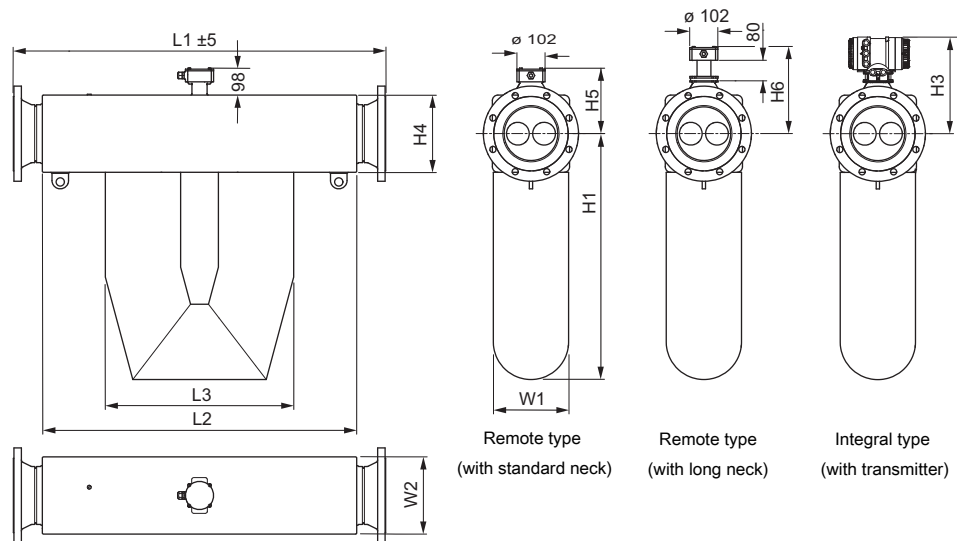

Fig. 22: Dimensions in mm

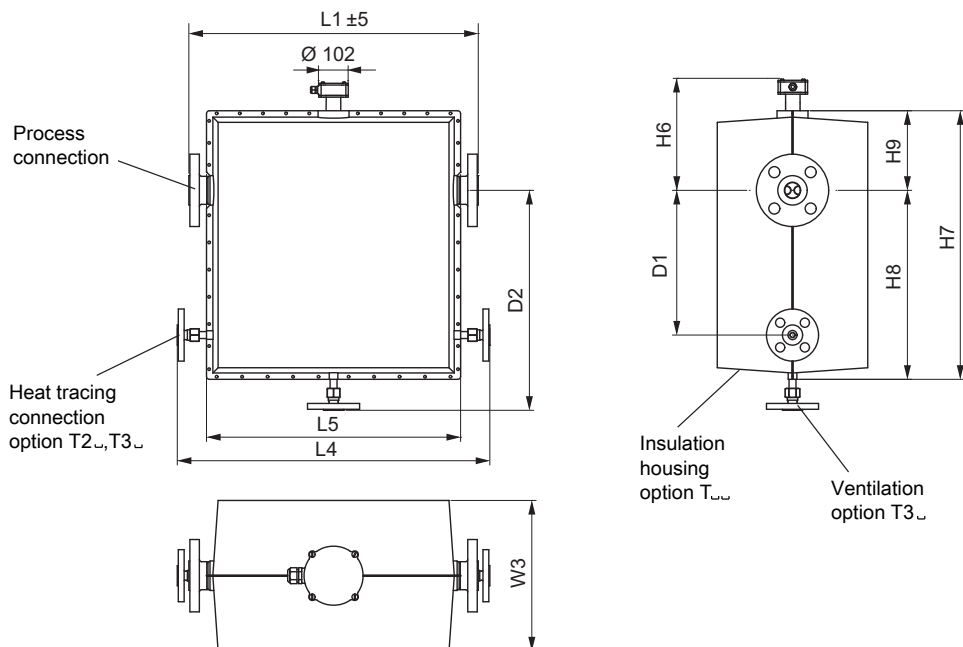

Fig. 23: Dimensions in mm: version with insulation housing

Tab. 17: Dimensions without length L1

Meter size	L2	L3	L4	L5	W1	W2	W3	D1	D2
	in mm (inch)								
Giga 1F	892 (35.1)	691 (27.2)	1050 (41.3)	944 (37.2)	168 (6.6)	176 (6.9)	342 (13.5)	350 (13.8)	677 (26.7)
Giga 2H	1140 (44.9)	683 (26.9)	–	–	273 (10.7)	280 (11)	–	–	–

Meaning of "–": not available

Tab. 18: Dimensions without length L1

Meter size	H1	H3	H4	H5	H6	H7	H8	H9
	in mm (inch)							
Giga 1F	556 (21.9)	327 (12.9)	176 (6.9)	186 (7.3)	266 (10.5)	824 (32.4)	625 (24.6)	196 (7.7)
Giga 2H	891 (35.1)	380 (15)	280 (11)	238 (9.4)	320 (12.6)	–	–	–

Meaning of "–": not available

Overall length L1 and weight

The overall length of the sensor depends on the selected process connection (type and size of flange). The following tables list the overall length and weight (without insulation or heat tracing and without customized installation length options) as functions of the individual process connection.

The weights in the tables are for the remote type with standard neck. Additional weight for the remote type with long neck: 1 kg (2.2 lb). Additional weight for the integral type: 3.5 kg (7.7 lb).

Process connections suitable for ASME B16.5

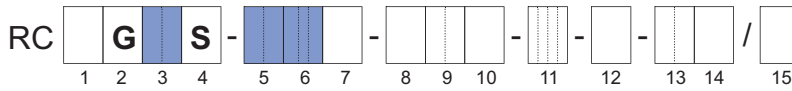

Tab. 19: Overall length L1 and weight of sensor (process connections: ASME, wetted parts: stainless steel)

Process connections	Model code pos.		Giga 1F		Giga 2H	
	5	6	L1 in mm (inch)	Weight in kg (lb)	L1 in mm (inch)	Weight in kg (lb)
ASME 4" class 150, raised face (RF)	1H	BA1	1100 (43.3)	95 (210)	–	–
ASME 4" class 300, raised face (RF)		BA2	1100 (43.3)	103 (227)	–	–
ASME 4" class 600, raised face (RF)		BA4	1100 (43.3)	112 (246)	–	–
ASME 4" class 600, ring joint (RJ)		CA4	1100 (43.3)	112 (247)	–	–
ASME 5" class 150, raised face (RF)	1Q	BA1	1100 (43.3)	97 (214)	–	–
ASME 5" class 300, raised face (RF)		BA2	1100 (43.3)	109 (239)	–	–
ASME 5" class 600, raised face (RF)		BA4	1160 (45.7)	136 (299)	–	–
ASME 5" class 600, ring joint (RJ)		CA4	1160 (45.7)	136 (301)	–	–

Process connections	Model code pos.		Giga 1F		Giga 2H	
	5	6	L1 in mm (inch)	Weight in kg (lb)	L1 in mm (inch)	Weight in kg (lb)
ASME 6" class 150, raised face (RF)	1F	BA1	1100 (43.3)	101 (223)	1350 (53.1)	290 (639)
ASME 6" class 300, raised face (RF)		BA2	1100 (43.3)	118 (259)	1350 (53.1)	307 (677)
ASME 6" class 600, raised face (RF)		BA4	1200 (47.2)	149 (329)	1390 (54.7)	332 (732)
ASME 6" class 600, ring joint (RJ)		CA4	1200 (47.2)	150 (331)	1390 (54.7)	333 (733)
ASME 8" class 150, raised face (RF)	2H	BA1	–	–	1350 (53.1)	302 (666)
ASME 8" class 300, raised face (RF)		BA2	–	–	1350 (53.1)	324 (714)
ASME 8" class 600, raised face (RF)		BA4	–	–	1440 (56.7)	371 (818)
ASME 8" class 600, ring joint (RJ)		CA4	–	–	1440 (56.7)	372 (821)

Meaning of "–": not available

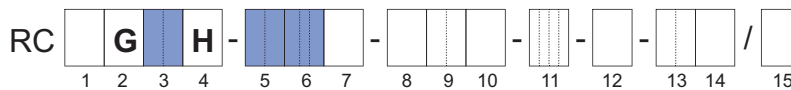

Tab. 20: Overall length L1 and weight of sensor (process connection: ASME, wetted parts: Ni alloy C-22/2.4602)

Process connections	Model code pos.		Giga 1F		Giga 2H	
	5	6	L1 in mm (inch)	Weight in kg (lb)	L1 in mm (inch)	Weight in kg (lb)
ASME 5" class 150, raised face (RF)	1Q	BA1	1100 (43.3)	99 (219)	–	–
ASME 5" class 300, raised face (RF)		BA2	1100 (43.3)	111 (245)	–	–
ASME 5" class 600, raised face (RF)		BA4	1110 (43.7)	133 (293)	–	–
ASME 6" class 150, raised face (RF)	1F	BA1	1100 (43.3)	106 (235)	–	–
ASME 6" class 300, raised face (RF)		BA2	1100 (43.3)	123 (270)	–	–

Meaning of "–": not available

Process connections suitable for EN 1092-1

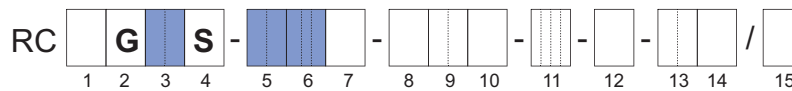

Tab. 21: Overall length L1 and weight of sensor (process connections: EN, wetted parts: stainless steel)

Process connections	Model code pos.		Giga 1F		Giga 2H	
	5	6	L1 in mm (inch)	Weight in kg (lb)	L1 in mm (inch)	Weight in kg (lb)
EN DN100 PN16, type B1, raised face (RF)	1H	BD2	1100 (43.3)	92 (202)	–	–
EN DN100 PN16, type D, with groove		GD2	1100 (43.3)	91 (201)	–	–
EN DN100 PN16, type E, with spigot		ED2	1100 (43.3)	91 (200)	–	–
EN DN100 PN16, type F, with recess		FD2	1100 (43.3)	91 (201)	–	–
EN DN100 PN40, type B1, raised face (RF)		BD4	1100 (43.3)	95 (209)	–	–
EN DN100 PN40, type D, with groove		GD4	1100 (43.3)	94 (208)	–	–
EN DN100 PN40, type E, with spigot		ED4	1100 (43.3)	94 (207)	–	–
EN DN100 PN40, type F, with recess		FD4	1100 (43.3)	94 (206)	–	–
EN DN100 PN63, type B1, raised face (RF)		BD5	1100 (43.3)	100 (220)	–	–
EN DN100 PN63, type D, with groove		GD5	1100 (43.3)	99 (219)	–	–
EN DN100 PN63, type E, with spigot		ED5	1100 (43.3)	98 (217)	–	–
EN DN100 PN63, type F, with recess		FD5	1100 (43.3)	99 (218)	–	–
EN DN100 PN100, type B1, raised face (RF)		BD6	1100 (43.3)	106 (233)	–	–
EN DN100 PN100, type D, with groove		GD6	1100 (43.3)	105 (232)	–	–
EN DN100 PN100, type E, with spigot		ED6	1100 (43.3)	104 (230)	–	–
EN DN100 PN100, type F, with recess		FD6	1100 (43.3)	105 (231)	–	–

Process connections	Model code pos.		Giga 1F		Giga 2H	
	5	6	L1 in mm (inch)	Weight in kg (lb)	L1 in mm (inch)	Weight in kg (lb)
EN DN125 PN16, type B1, raised face (RF)	1Q	BD2	1100 (43.3)	95 (209)	–	–
EN DN125 PN16, type D, with groove		GD2	1100 (43.3)	94 (208)	–	–
EN DN125 PN16, type E, with spigot		ED2	1100 (43.3)	94 (206)	–	–
EN DN125 PN16, type F, with recess		FD2	1100 (43.3)	94 (207)	–	–
EN DN125 PN40, type B1, raised face (RF)		BD4	1100 (43.3)	99 (218)	–	–
EN DN125 PN40, type D, with groove		GD4	1100 (43.3)	99 (217)	–	–
EN DN125 PN40, type E, with spigot		ED4	1100 (43.3)	98 (216)	–	–
EN DN125 PN40, type F, with recess		FD4	1100 (43.3)	98 (216)	–	–
EN DN125 PN63, type B1, raised face (RF)		BD5	1100 (43.3)	109 (240)	–	–
EN DN125 PN63, type D, with groove		GD5	1100 (43.3)	108 (239)	–	–
EN DN125 PN63, type E, with spigot		ED5	1100 (43.3)	107 (237)	–	–
EN DN125 PN63, type F, with recess		FD5	1100 (43.3)	108 (238)	–	–
EN DN125 PN100, type B1, raised face (RF)		BD6	1140 (44.9)	121 (267)	–	–
EN DN125 PN100, type D, with groove		GD6	1140 (44.9)	121 (266)	–	–
EN DN125 PN100, type E, with spigot		ED6	1140 (44.9)	119 (263)	–	–
EN DN125 PN100, type F, with recess		FD6	1140 (44.9)	120 (265)	–	–

Process connections	Model code pos.		Giga 1F		Giga 2H	
	5	6	L1 in mm (inch)	Weight in kg (lb)	L1 in mm (inch)	Weight in kg (lb)
EN DN150 PN16, type B1, raised face (RF)	1F	BD2	1100 (43.3)	98 (216)	1350 (53.1)	288 (634)
EN DN150 PN16, type D, with groove		GD2	1100 (43.3)	98 (215)	1350 (53.1)	287 (633)
EN DN150 PN16, type E, with spigot		ED2	1100 (43.3)	97 (214)	1350 (53.1)	286 (631)
EN DN150 PN16, type F, with recess		FD2	1100 (43.3)	97 (214)	1350 (53.1)	287 (632)
EN DN150 PN40, type B1, raised face (RF)		BD4	1100 (43.3)	105 (231)	1350 (53.1)	294 (648)
EN DN150 PN40, type D, with groove		GD4	1100 (43.3)	104 (230)	1350 (53.1)	293 (647)
EN DN150 PN40, type E, with spigot		ED4	1100 (43.3)	103 (228)	1350 (53.1)	293 (645)
EN DN150 PN40, type F, with recess		FD4	1100 (43.3)	104 (228)	1350 (53.1)	293 (646)
EN DN150 PN63, type B1, raised face (RF)		BD5	1140 (44.9)	124 (274)	1350 (53.1)	311 (685)
EN DN150 PN63, type D, with groove		GD5	1140 (44.9)	124 (273)	1350 (53.1)	310 (684)
EN DN150 PN63, type E, with spigot		ED5	1140 (44.9)	122 (269)	1350 (53.1)	309 (681)
EN DN150 PN63, type F, with recess		FD5	1140 (44.9)	123 (272)	1350 (53.1)	310 (683)
EN DN150 PN100, type B1, raised face (RF)		BD6	1180 (46.5)	138 (303)	–	–
EN DN150 PN100, type D, with groove		GD6	1180 (46.5)	137 (302)	–	–
EN DN150 PN100, type E, with spigot		ED6	1180 (46.5)	136 (299)	–	–
EN DN150 PN100, type F, with recess		FD6	1180 (46.5)	137 (301)	–	–

Process connections	Model code pos.		Giga 1F		Giga 2H	
	5	6	L1 in mm (inch)	Weight in kg (lb)	L1 in mm (inch)	Weight in kg (lb)
EN DN200 PN16, type B1, raised face (RF)	2H	BD2	–	–	1350 (53.1)	294 (649)
EN DN200 PN16, type D, with groove		GD2	–	–	1350 (53.1)	294 (647)
EN DN200 PN16, type E, with spigot		ED2	–	–	1350 (53.1)	293 (646)
EN DN200 PN16, type F, with recess		FD2	–	–	1350 (53.1)	293 (646)
EN DN200 PN40, type B1, raised face (RF)		BD4	–	–	1350 (53.1)	311 (685)
EN DN200 PN40, type D, with groove		GD4	–	–	1350 (53.1)	310 (683)
EN DN200 PN40, type E, with spigot		ED4	–	–	1350 (53.1)	308 (680)
EN DN200 PN40, type F, with recess		FD4	–	–	1350 (53.1)	309 (682)
EN DN200 PN63, type B1, raised face (RF)		BD5	–	–	1350 (53.1)	333 (733)
EN DN200 PN63, type D, with groove		GD5	–	–	1350 (53.1)	332 (732)
EN DN200 PN63, type E, with spigot		ED5	–	–	1350 (53.1)	330 (728)
EN DN200 PN63, type F, with recess		FD5	–	–	1350 (53.1)	331 (730)

Meaning of "–": not available

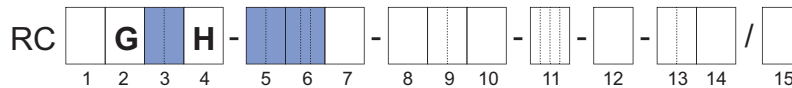

Tab. 22: Overall length L1 and weight of sensor (process connections: EN, wetted parts: Ni alloy C-22/2.4602)

Process connections	Model code pos.		Giga 1F		Giga 2H	
	5	6	L1 in mm (inch)	Weight in kg (lb)	L1 in mm (inch)	Weight in kg (lb)
EN DN125 PN16, type B1, raised face (RF)	1Q	BD2	1100 (43.3)	96 (212)	–	–
EN DN125 PN40, type B1, raised face (RF)		BD4	1100 (43.3)	101 (222)	–	–
EN DN150 PN16, type B1, raised face (RF)	1F	BD2	1100 (43.3)	103 (227)	–	–
EN DN150 PN40, type B1, raised face (RF)		BD4	1100 (43.3)	110 (241)	–	–

Meaning of "–": not available

Process connections suitable for JIS B 2220

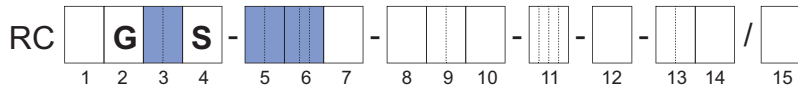

Tab. 23: Overall length L1 and weight of sensor (process connections: JIS, wetted parts: stainless steel)

Process connections	Model code pos.		Giga 1F		Giga 2H	
	5	6	L1 in mm (inch)	Weight in kg (lb)	L1 in mm (inch)	Weight in kg (lb)
JIS DN100 10K	1H	BJ1	1100 (43.3)	91 (200)	–	–
JIS DN100 20K		BJ2	1100 (43.3)	94 (208)	–	–
JIS DN125 10K	1Q	BJ1	1100 (43.3)	94 (207)	–	–
JIS DN125 20K		BJ2	1100 (43.3)	101 (222)	–	–

Meaning of "–": not available

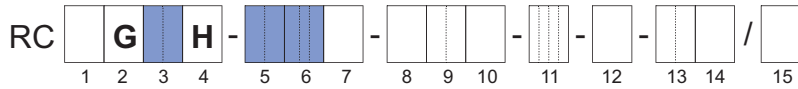

Tab. 24: Overall length L1 and weight of sensor (process connections: JIS, wetted parts: Ni alloy C-22/2.4602)

Process connections	Model code pos.		Giga 1F		Giga 2H	
	5	6	L1 in mm (inch)	Weight in kg (lb)	L1 in mm (inch)	Weight in kg (lb)
JIS DN125 10K	1Q	BJ1	1100 (43.3)	97 (213)	–	–
JIS DN125 20K		BJ2	1100 (43.3)	103 (228)	–	–

Meaning of "–": not available

NAMUR & Customer length

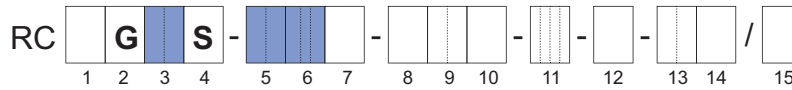

Overall length and weight for customized installation length

Tab. 25: Available process connections for options NL and CL with minimum and maximum installation length

Model code position		Giga 1F	
5	6	CL min in mm (inch)	CL max (NL) in mm (inch)
1H	BA1, BA2, BA4, BD2, BD4, BJ1, BJ2, CA4, ED2, ED4, FD2, FD4, GD2, GD4	1160 (45.7)	1400 (55.1)
1Q	BA1, BA2, BA4, BD2, BD4, BJ1, BJ2, CA4, ED2, ED4, FD2, FD4, GD2, GD4	1160 (45.7)	1400 (55.1)
1F	BA1, BA2, BA4, BD2, BD4, CA4, ED2, ED4, FD2, FD4, GD2, GD4	1160 (45.7)	1400 (55.1)

Meaning of "CL": Customer length, "NL": NAMUR length; NL corresponds to CL max

Tab. 26: Additional weight in combination with options NL and CL

	Giga 1F
Additional weight for customized installation length in kg/mm	0.021 kg/mm

6.4 Transmitter dimensions and weights

Transmitter dimensions

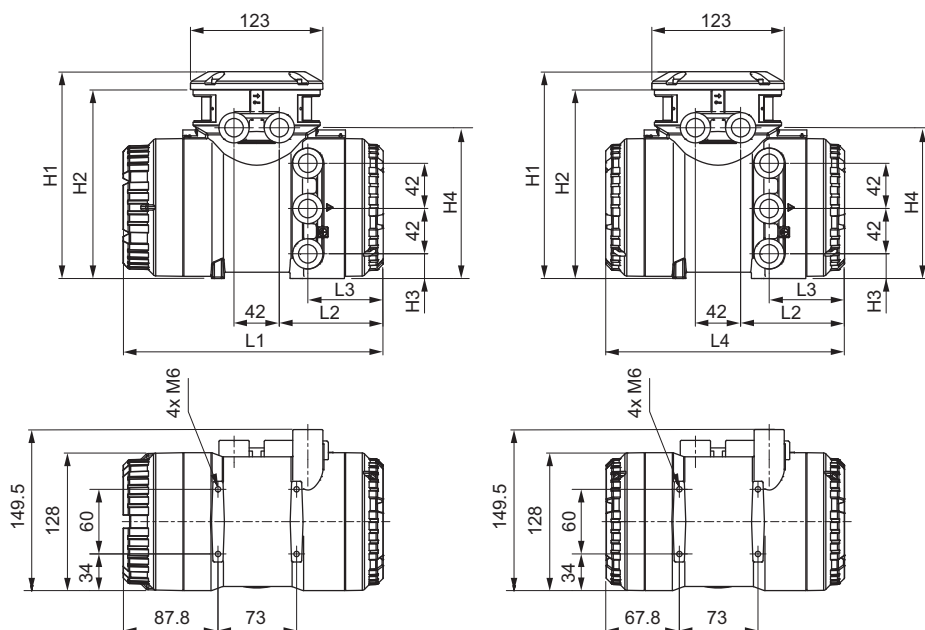

Fig. 24: Dimensions of transmitter in mm (left: transmitter with display, right: transmitter without display)

Tab. 27: Overall length L1 - L4 and height H1 - H4 of transmitter (material: stainless steel, aluminum)

Material	L1 in mm (inch)	L2 in mm (inch)	L3 in mm (inch)	L4 in mm (inch)	H1 in mm (inch)	H2 in mm (inch)	H3 in mm (inch)	H4 in mm (inch)
Stainless steel	255.5 (10.06)	110.5 (4.35)	69 (2.72)	235 (9.25)	201 (7.91)	184 (7.24)	24 (0.94)	150.5 (5.93)
Aluminum	241.5 (9.51)	96.5 (3.8)	70 (2.76)	221 (8.7)	192 (7.56)	175 (6.89)	23 (0.91)	140 (5.51)

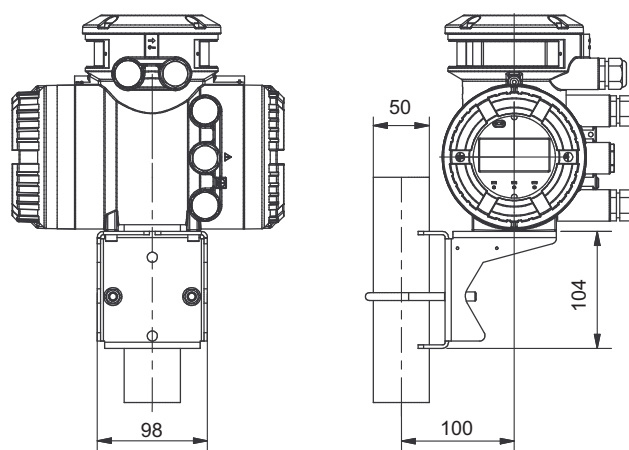
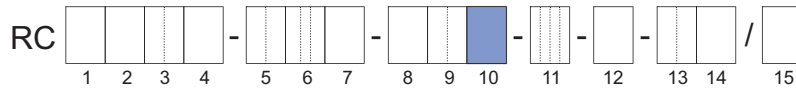

Fig. 25: Dimensions of transmitter in mm, attached to mounting bracket.

Transmitter weights



Model code (pos. 10)	Design type	Housing material of transmitter	Weight in kg (lb)
A, B, E, F	Remote	Aluminum	4.2 (9.3)
J, K		Stainless steel	12.5 (27.6)

7 Transmitter specification

Overview of functional scope of the Rotamass transmitter

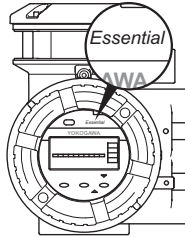
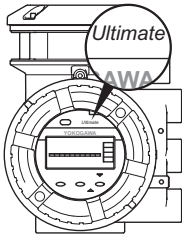
Functional scope	Transmitter	
	Essential	Ultimate
		
Model code (position 1)	E	U
4-line Dot-Matrix display	●	●
Universal power supply (V_{DC} and V_{AC})	●	●
microSD card	●	●
Installation		
Integral type	●	●
Remote type	●	●
Special functions		
Wizard	●	●
Event management	●	●
Total Health Check ¹⁾ (diagnostic function)	●	●
Dynamic pressure compensation ³⁾	–	●
Advanced functions		
Features on Demand	–	●
Standard concentration measurement	–	●
Advanced concentration measurement	–	●
Measurement of heat quantity ³⁾	–	●
Net Oil Computing following API standard	–	●
Tube Health Check (diagnostic function)	●	●
Batching function ²⁾	–	●
Viscosity function ³⁾	–	●
Inputs and outputs		
Analog output	●	●
Pulse/frequency output	●	●
Status output	●	●
Analog input	–	●
Status input	●	●
Communication		
HART	●	●
Modbus	●	●
PROFIBUS PA	–	●

meaning of "–": not available;
meaning of "●": available

¹⁾ Function is based on external software (FieldMate)

²⁾ Only in combination with 1 or 2 status outputs

³⁾ Only in combination with an analog input or PROFIBUS PA

7.1 HART and Modbus

7.1.1 Inputs and outputs

Depending on the flow meter specification, there are different configurations of the connection terminal. Following are configuration examples of the connection terminal (value JK and M7 on model code position 13 - see *Communication type and I/O* [▶ 107] for details):

HART

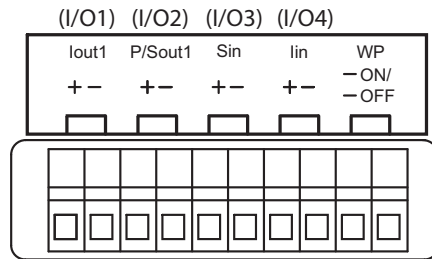

- I/O1: Iout1 Current output (active/passive)
- I/O2: P/Sout1 Pulse or status output (passive)
- I/O3: Sin Status input
- I/O4: Iin Current input (active/passive)
- WP: Write-protect bridge

Modbus

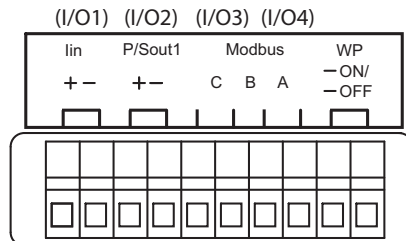

- I/O1: Iin Current input (passive)
- I/O2: P/Sout1 Pulse or status output (passive)
- I/O3-I/O4: Modbus RS485 input/output
- WP: Write-protect bridge

7.1.1.1 Output signals

Galvanic isolation All circuits for inputs, outputs and power supply are galvanically isolated from each other.

Active current output *lout* One or two current outputs are available depending on model code position 13. Depending on the measured value, the active current output delivers 4 – 20 mA.

It may be used for output of the following measured values:

- Flow rate (mass, volume, net partial component flow of a mixture)
- Density
- Temperature
- Pressure
- Concentration

For HART communication devices, it is supplied on the current output *lout1*. The current output may be operated in compliance with the NAMUR NE43 standard.

	Value
Nominal output current	4 – 20 mA
Maximum output current range	2.4 – 21.6 mA
Load resistance	≤ 750 Ω
Load resistance for secure HART communication	230 – 600 Ω

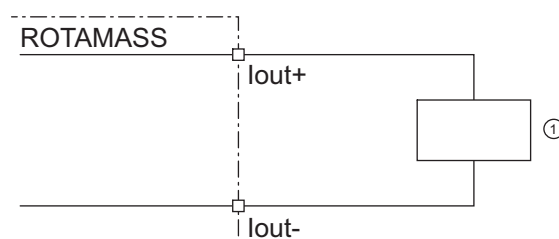

Fig. 26: Active current output connection *lout* HART

① Receiver

Passive current output *I_{out}*

	Value
Nominal output current	4 – 20 mA
Maximum output current range	2.4 – 21.6 mA
External power supply	10.5 – 32 V _{DC}
Load resistance for secure HART communication	230 – 600 Ω
Load resistance at current output	≤ 911 Ω

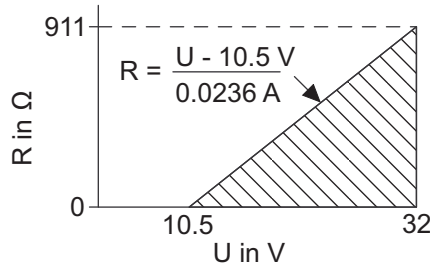

Fig. 27: Maximum load resistance as a function of an external power supply voltage

- R Load resistance
- U External power supply voltage

The diagram shows the maximum load resistance R as a function of voltage U of the connected voltage source. Higher load resistances are allowed with higher power supply values. The usable zone for passive power output operation is indicated by the hatched area.

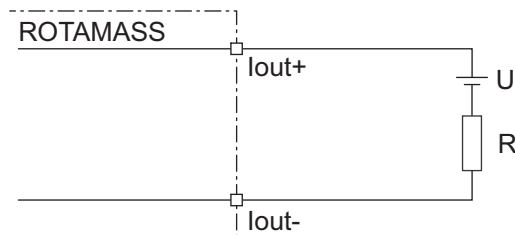

Fig. 28: Passive current output connection *I_{out}*

Analog output specification *I_{out}*

If mass- or volume flow is measured via current output *I_{out}* two additional deviation effects have to be taken into account.

- The *I_{out}* –base specification ΔI_{base} contains all combined effects of output adjustment, linearity, power supply variation, load resistance variation, short and long term drift for one year.
- The *I_{out}* –ambient temperature specification $\Delta I(T_{amb})$ gives an additional deviation effect if the ambient temperature of the transmitter differs from 20 °C.

Both additional output deviation effects have to be added to the basic massflow, or volume flow deviation. They are based on a 95 % (2σ) confidence level.

Deviation of mass- or volume flow by *I_{out}*

The following formula can be used to calculate the deviation of mass- or volume flow:

$$D_1 = \sqrt{D^2 + \left(\frac{\Delta I_{\text{base}}}{I(Q)} \times 100 \%\right)^2 + \left(\frac{\Delta I(T_{\text{amb}})}{I(Q)} \times 100 \%\right)^2}$$

- D_1 Maximum deviation of mass- or volume flow by *I_{out}* in %
- D Maximum deviation of mass- or volume flow¹⁾ by pulse/frequency output in %
- $I(Q)$ *I_{out}* depending on mass- or volume flow in μA
- ΔI_{base} Maximum deviation of *I_{out}* by combined effects
 $\Delta I_{\text{base}} = a \times I(Q) + b$
- $\Delta I(T_{\text{amb}})$ Maximum deviation of *I_{out}* by deviation of the transmitter ambient temperature from 20 °C
 $\Delta I(T_{\text{amb}}) = (c \times I(Q) + d) \times (T - 20 \text{ °C})$
- a, b, c, d Constants

Description	Model code pos. 13	a in ppm	b in μA	c in ppm/°C	d in $\mu\text{A}/^\circ\text{C}$
Non-intrinsically safe <i>I_{out}</i> (active or passive)	JA, JB, JC, JD, JE, JF, JG, JH, JJ, JK, JL, JM, JN, M6	170	2.3	7	0
Intrinsically safe <i>I_{out}</i> (passive)	JP, JQ, JR, JS				0.06

¹⁾Formula of volume flow accuracy D_v , please see chapter 4.6 *Volume flow accuracy* [▶ 20]

**Active pulse output
P/Sout**

Connection of an electronic counter

Maximum voltage and correct polarity must be observed for wiring.

	Value
Load resistance	> 1 kΩ
Internal power supply	24 V _{DC} ±20 %
Maximum pulse rate	10000 pulses/s
Frequency range	0 – 12.5 kHz

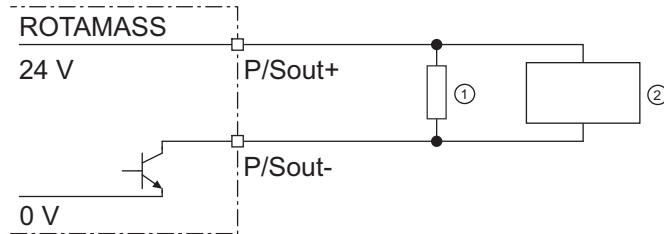

Fig. 29: Active pulse output connection P/Sout

- ① Load resistance
- ② Electronic counter

Connection of an electromechanical counter

	Value
Maximum current	150 mA
Average current	≤ 30 mA
Internal power supply	24 V _{DC} ±20 %
Maximum pulse rate	2 pulses/s
Pulse width	20, 33, 50, 100 ms

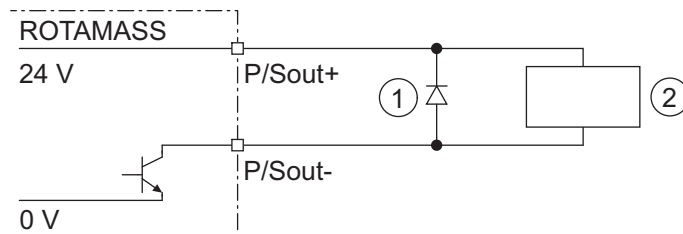

Fig. 30: Active pulse output P/Sout connection with electromechanical counter

- ① Protective diode
- ② Electromechanical counter

**Active pulse output
P/Sout with internal
pull-up resistor**

	Value
Internal power supply	24 V _{DC} ±20 %
Internal pull-up resistor	2.2 kΩ
Maximum pulse rate	10000 pulses/s
Frequency range	0 – 12.5 kHz

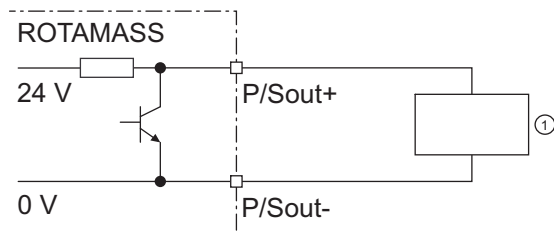

Fig. 31: Active pulse output P/Sout with internal pull-up resistor

- ① Electronic counter

Passive pulse output *P/Sout*

Maximum voltage and correct polarity must be observed for wiring.

	Value
Maximum load current	≤ 200 mA
Power supply	≤ 30 V _{DC}
Maximum pulse rate	10000 pulses/s
Frequency range	0 – 12.5 kHz

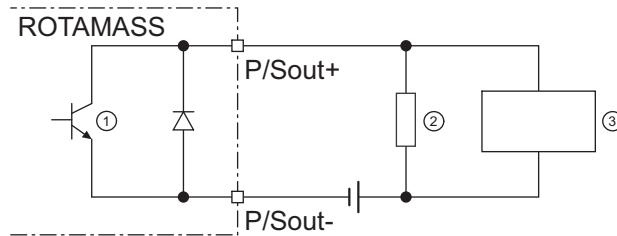

Fig. 32: Passive pulse output connection *P/Sout* with electronic counter

- ① Passive pulse or status output
- ② Load resistance
- ③ Electronic counter

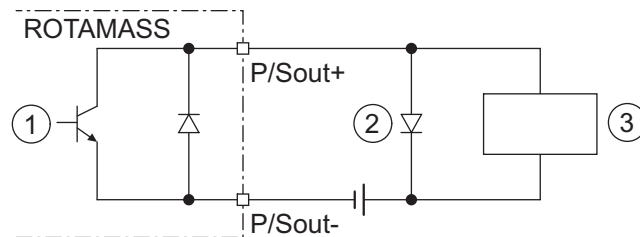

Fig. 33: Passive pulse output *P/Sout* connection with electromechanical counter

- ① Passive pulse or status output
- ② Protective diode
- ③ Electromechanical counter

Active status output P/Sout

Since this is a transistor contact, maximum allowed current as well as polarity and level of output voltage must be observed during wiring.

	Value
Load resistance	> 1 k Ω
Internal power supply	24 V _{DC} \pm 20 %

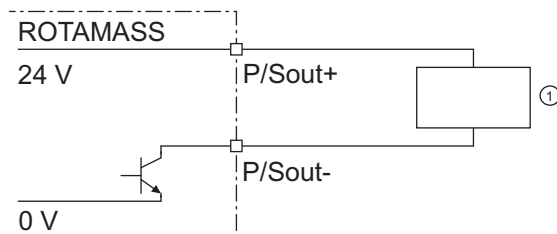

Fig. 34: Active status output connection P/Sout

- ① External device with load resistance

Active status output P/Sout with internal pull-up resistor

	Value
Internal pull-up resistor	2.2 k Ω
Internal power supply	24 V _{DC} \pm 20 %

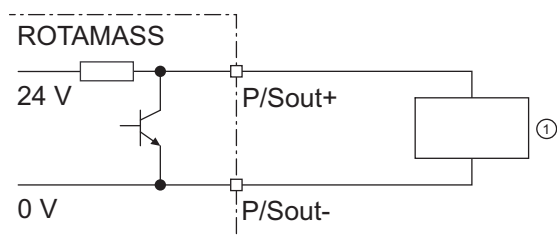

Fig. 35: Active status output P/Sout with internal pull-up resistor

- ① External device

Passive status output P/Sout or Sout

	Value
Output current	≤ 200 mA
Power supply	≤ 30 V _{DC}

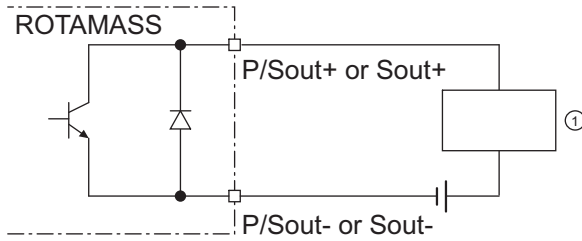

Fig. 36: Passive status output connection P/Sout or Sout

- ① External device

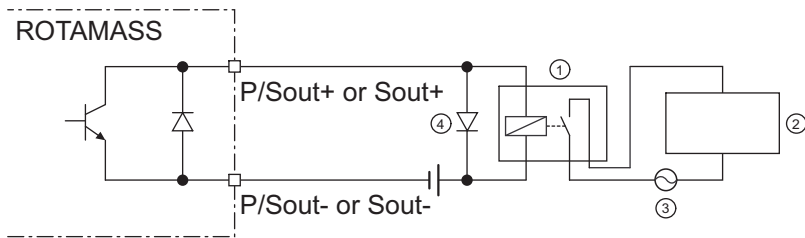

Fig. 37: Passive status output connection P/Sout or Sout for solenoid valve circuit

- ① Relay
- ② Solenoid valve
- ③ Magnetic valve power supply
- ④ Protective diode

A relay must be connected in series to switch alternating voltage.

Passive pulse or status output P/Sout (NAMUR)

Output signals according to EN 60947-5-6 (previously NAMUR, worksheet NA001):

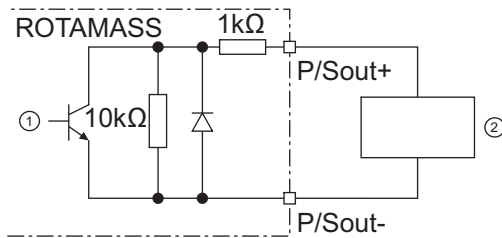

Fig. 38: Passive pulse or status output with switching amplifier connected in series

- ① Passive pulse or status output
- ② Switching amplifier

7.1.1.2 Input signals

Active current input *lin*

An individual analog power input is available for external analog devices.

The active current input *lin* is provided for connecting a two-wire transmitter with an output signal of 4 – 20 mA.

	Value
Nominal input current	4 – 20 mA
Maximum input current range	2.4 – 21.6 mA
Internal power supply	24 V _{DC} ±20 %
Internal load resistance Rotamass	≤ 160 Ω

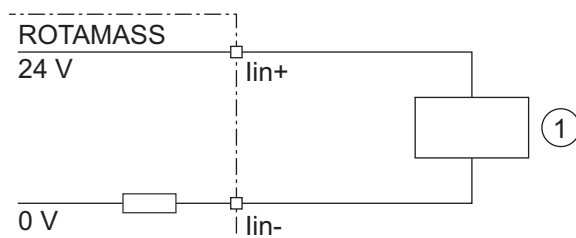

Fig. 39: Connection of external device with passive current output

① External passive current output device

Passive current input *lin*

The passive current input *lin* is provided for connecting a four-wire transmitter with an output signal of 4 – 20 mA.

	Value
Nominal input current	4 – 20 mA
Maximum input current range	2.4 – 21.6 mA
Maximum input voltage	≤ 32 V _{DC}
Internal load resistance Rotamass	≤ 160 Ω

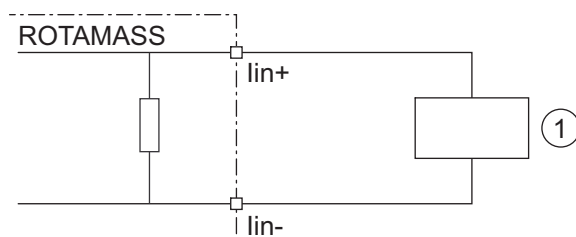

Fig. 40: Connection of external device with active current output

① External active current output device

Status input *Sin*

Do not connect a signal source with electric voltage.

The status input is provided for use of voltage-free contacts with the following specification:

Switching status	Resistance
Closed	< 200 Ω
Open	> 100 k Ω

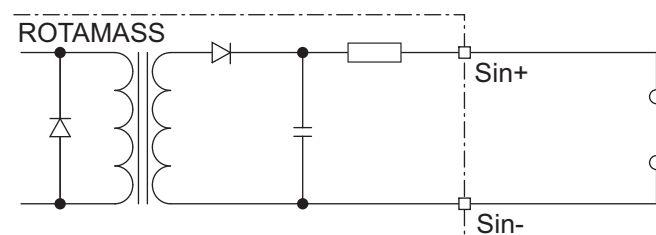

Fig. 41: Status input connection

7.2 PROFIBUS PA

7.2.1 Overview of functional scope

Output signal:		
Digital communication signal based on PROFIBUS PA protocol (Profile Revision R3.02 Compliant)		
PROFIBUS PA block specifications:		
▪ Transducer block (TB):		
	Flow Transducer Block (FTB)	•
	Concentration Transducer Block (CTB)	optional
	LCD Indicator Transducer Block (LTB)	•
	Maintenance Transducer Block (MTB)	•
	Advanced Diagnostic Transducer Block (ADTB)	optional
▪ Analog Input block (AI):¹⁾		
	AI1: Mass flow	•
	AI2: Density	•
	AI3: Temperature	•
	AI4: Volume flow	•
	AI5: Reference density	•
	AI6: Corrected volume flow	•
▪ Totalizer block (TOT):¹⁾		
	TOT1: Mass	•
	TOT2: Volume	•
	TOT3: Corrected volume flow	•
▪ Analog output block (AO):¹⁾		
	AO: Pressure	•
▪ Profile Revision R3.02:		
	Condensed Status (NE 107)	•
	Life Cycle Management (Automatic IDENT_NUMBER adaptation)	•
▪ DP-V0 cyclic data:		
	AI x 6, TOT x 3, AO x 1	•
▪ IDENT NUMBER:		
	0x45A0 (manufacturer specific)	•
	0x9740, 0x9741, 0x9742 (profile specific)	•
▪ GSD:		
	YEC45A0.gsd, pa139740.gsd, pa139741.gsd, pa139742.gsd	•
Conditions of Communication Line:		
Supply voltage from the Bus:	9 to 32 V _{DC}	•
Current draw:	15 mA (maximum)	•

Bus address switch:
via Hardware address switch or via Software
Alarm selection function:
These informations are indicated in DIAGNOSTICS parameter, which can be handled during normal operation.
Displayed language:
In the case of PROFIBUS PA communication type, different language packages are possible to choose.

¹⁾ Factory default setting; can be changed by parameter "Channel".
 meaning of "•": available

7.2.2 Inputs and outputs

For the PROFIBUS PA version there is only one configuration of the connection terminal. Following is the configuration of the connection terminal (value G0 and G1 on model code position 13, see *Communication type and I/O [107]* for details):

PROFIBUS PA

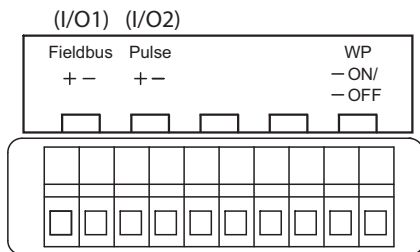

I/O1: Fieldbus PROFIBUS PA communication
 I/O2: Pulse Pulse / Frequency output
 WP: Write-protect bridge

7.2.2.1 Output signals PROFIBUS PA

Digital communication signal based on PROFIBUS PA protocol.
 Maximum voltage and correct polarity must be observed for wiring.

	Value
Power supply	9 to 32 V _{DC}
Current draw	15 mA (maximum)

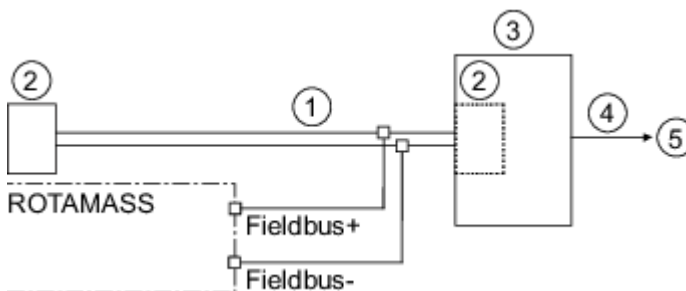

Fig. 42: PROFIBUS PA connection

- ① PROFIBUS PA
- ② Termination
- ③ DP/PA-Coupler
- ④ PROFIBUS DP
- ⑤ Host

**Passive pulse
output (only for
calibration)**

	Value
Maximum load current	≤ 200 mA
Power supply	≤ 30 V _{DC}
Maximum pulse rate	10000 pulses/s
Frequency range	0 – 12.5 kHz

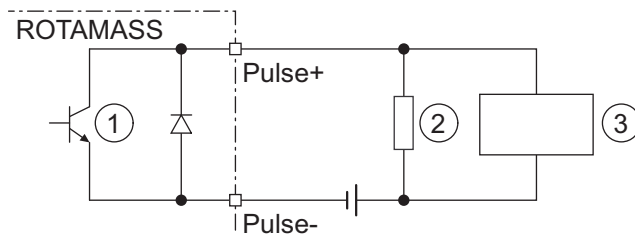

Fig. 43: Passive pulse output connection with electronic counter

- ① Passive pulse
- ② Load resistance
- ③ Electronic counter

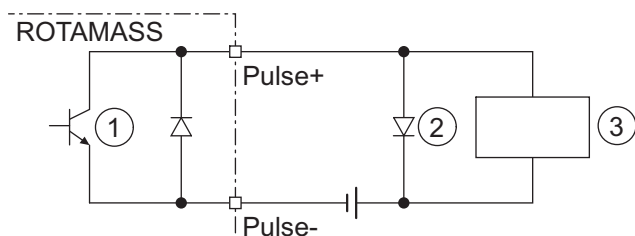

Fig. 44: Passive pulse output connection with electromechanical counter

- ① Passive pulse
- ② Protective diode
- ③ Electromechanical counter

7.3 Power supply

Power supply	<p>Alternating-current voltage (rms):</p> <ul style="list-style-type: none"> Power supply¹⁾: 24 V_{AC} +20 % -15 % or 100 – 240 V_{AC} +10 % -20 % Power frequency: 47 – 63 Hz <p>Direct-current voltage:</p> <ul style="list-style-type: none"> Power supply¹⁾: 24 V_{DC} +20 % -15 % or 100 – 120 V_{DC} +8,3 % -10 % <p>¹⁾ for option MC_ (DNV GL approval) supply voltage is limited to 24 V; in addition NE21 testing indicates a tolerable area of 24 V_{DC} ±20 % under NE21 test conditions.</p>
Power consumption	P ≤ 10 W (including sensor)
Power supply failure	In the event of a power failure, the flow meter data are backed up on a non-volatile internal memory. In case of devices with display, the characteristic sensor values, such as nominal diameter, serial number, calibration constants, zero point, etc. and the error history are also stored on a microSD card.

7.4 Cable specification

With the remote type, the original connecting cable from Rota Yokogawa must be used to connect the sensor with the transmitter. The connecting cable included in the delivery may be shortened. An assembly set along with the appropriate instructions are enclosed for this purpose.

The connecting cable can be ordered as option in various lengths as a standard type (device options L_ _ _) or as marine approved fire retardant cable (device options Y_ _ _), see chapters *Connecting cable type and length* [▶ 112] and *Marine approval* [▶ 119] for details.



The maximum cable length to keep the specification is 30 m (98.4 ft). Longer cables must be ordered as a separate item. For this purpose please check the "Customers Maintenance Parts List" (Ref.: CMPL 01U10B00-00EN-R) or consult our Yokogawa Service team.

8 Advanced functions and Features on Demand (FOD)

Rotamass Total Insight includes many dedicated application and maintenance functions that can be ordered simultaneously with the device or can be purchased and activated in a second time (Features on Demand).

Advanced functions

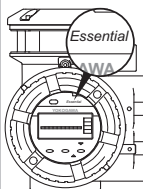
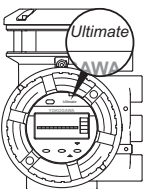
Functional scope	Transmitter		Communication type and I/O			
	Essential	Ultimate	Available type			Mandatory I/O
			HART	Modbus	PROFIBUS PA	
Model code (pos. 1 and pos. 13)	E	U	J_	M_	G_	
Standard concentration measurement	-	•	•	•	•	Not applicable
Advanced concentration measurement	-	•	•	•	•	
Net Oil Computing following API standard	-	•	•	•	•	
Tube Health Check	•	•	•	•	•	
Batching function	-	•	•	-	-	1 status output for one-stage batching 2 status outputs for two-stage batching
Viscosity function	-	•	•	-	•	1 analog input for J_
Measurement of heat quantity	-	•	•	•	•	1 analog input for J_ and M_

meaning of "-": not available;
meaning of "•": available

8.1 Concentration and petroleum measurement

Standard concentration measurement

The standard concentration measurement (option CST) can be used for concentration measurements of emulsions or suspensions when density of the fluid involved depends only on temperature.

The standard concentration measurement can also be used for many low-concentration solutions if there is only minor interaction between the liquids or if the miscibility is negligible. For questions regarding a specific application, contact the responsible Yokogawa sales organization. The appropriate density coefficients must be determined prior to using this option and input into the transmitter. To do so, the recommendation is to determine the necessary parameters from density data using DTM in the Yokogawa FieldMate program or the calculation tool included in the delivery.

Petroleum measurement function NOC (option C52)

"NOC" is an abbreviation for the "Net Oil Computing" function that provides real-time measurements of water cut and includes "API" (American Petroleum Institute) correction according to API MPMS Chapter 11.1.

Oil sometimes contains entrained gas. Rotamass Total Insight measures the density of the emulsion oil and gas that result to be lower than the oil density. If the measured density is used to calculate volume flow of oil, the result would not be correct. Therefore NOC function (option C52) includes also a Gas Void Fraction function (GVF). GVF may reduce the error in oil volume flow calculation at a minimum recognizing the occurrence of gas in the oil and using the oil density to calculate the volume flow.

Oil properties can be selected using Oil type's pre-settings or using "Alpha 60".

Oil and water types predefined in the functions	
Oil types	Water types
<ul style="list-style-type: none"> ▪ Crude ▪ Refined Products: Fuel, Jet Fuel, Transition, Gasoline ▪ Lubricating ▪ Custom Oil 	<ul style="list-style-type: none"> ▪ Standard Mean Ocean Water ▪ UNESCO 1980 ▪ Fresh water density by API MPMS 11.4 ▪ Produced water density by API MPMS 20.1 Appendix A.1 ▪ Brine water density by El-Dessouky, Ettouy (2002) ▪ Custom

In addition to water cut, the function can calculate: Net oil mass flow, net water mass flow, net oil volume flow, net water volume flow and net corrected oil volume flow.

Advanced concentration measurement

The advanced concentration measurement (option AC_) is recommended for more complex applications, such as for liquids that interact.

Following is a table that lists possible pre-configured concentrations. The desired data sets must be requested by the customer to the Yokogawa sales organization at the time the order is placed. The customer is responsible to ensure chemical compatibility of the material of the wetted parts with the measured chemicals. For strong acids or oxidizers which attack steel pipes a variant with wetted parts made of Ni alloy C-22/2.4602 is necessary.

Set	Fluid A / B	Concentration range	Unit	Temperature range in °C	Density range in kg/l	Data source for density data
C01	Sugar / Water	0 – 85	°Bx	0 – 80	0.97 – 1.45	PTB... Messages 100 5/90: "The density of watery sucrose solutions after the introduction of the international temperature scale of 1990 (ITS1990)" Table 5
C02 ¹⁾	NaOH / Water	0 – 54	WT%	0 – 100	0.95 – 1.58	D'Ans-Lax, Handbook for chemists and physicists Vol.1, 3rd edition, 1967
C03	KOH / Water	1 – 55	WT%	54 – 100	1.01 – 1.58	D'Ans-Lax, Handbook for chemists and physicists Vol.1, 3rd edition, 1967
C04	NH ₄ NO ₃ / Water	1 – 50	WT%	0 – 80	0.97 – 1.24	Table of density data on request
C05	NH ₄ NO ₃ / Water	20 – 70	WT%	20 – 100	1.04 – 1.33	Table of density data on request
C06 ¹⁾	HCl / Water	22 – 34	WT%	20 – 60	1.08 – 1.17	D'Ans-Lax, Handbook for chemists and physicists Vol.1, 3rd edition, 1967
C07	HNO ₃ / Water	50 – 67	WT%	10 – 60	1.26 – 1.40	Table of density data on request
C09 ¹⁾	H ₂ O ₂ / Water	30 – 75	WT%	4.5 – 43.5	1.00 – 1.20	Table of density data on request
C10 ¹⁾	Ethylene glycol / Water	10 – 50	WT%	-20 – 40	1.005 – 1.085	Table of density data on request
C11	Starch / Water	33 – 42.5	WT%	35 – 45	1.14 – 1.20	Table of density data on request
C12	Methanol / Water	35 – 60	WT%	0 – 40	0.89 – 0.96	Table of density data on request
C20	Alcohol / Water	55 – 100	VOL%	10 – 40	0.76 – 0.94	Table of density data on request
C21	Sugar / Water	40 – 80	°Bx	75 – 100	1.15 – 1.35	Table of density data on request
C30	Alcohol / Water	66 – 100	WT%	15 – 40	0.77 – 0.88	Standard Copersucar 1967
C37	Alcohol / Water	66 – 100	WT%	10 – 40	0.772 – 0.885	Brazilian Standard ABNT

¹⁾ We recommend using devices with wetted parts made of nickel alloy C22. Contact the Yokogawa sales organization about availability.

Maximum 4 C_ option sets can be ordered for one device simultaneously.

For details about the ordering information, see *Concentration and petroleum measurement* [▶ 113].

8.2 Batching function

Batching and filling processes are typical applications in different industries as food and beverage, cosmetic, pharmaceutical, chemical and oil & gas.

Rotamass Total Insight offers an integrated “Batching function” to automatize the task. A “self-learning” algorithm optimizes the process and allows high accurate results.

The function supports two filling modes:

- one-stage mode with single valve
- two-stage mode to control two valves for accurate filling

Without using an external flow computer, data related to the process can be transmitted via communication protocol. The error management function allows the user to set alarms and warnings accordingly the application needs.

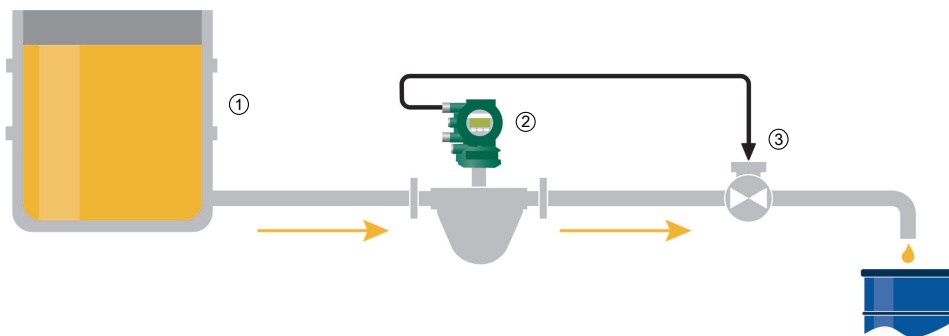

Fig. 45: One-stage mode (The above diagram illustrates the fundamental functionality for one of several combination possibilities)

- | | |
|--------------------------|---------|
| ① Storage tank | ③ Valve |
| ② Rotamass Total Insight | |

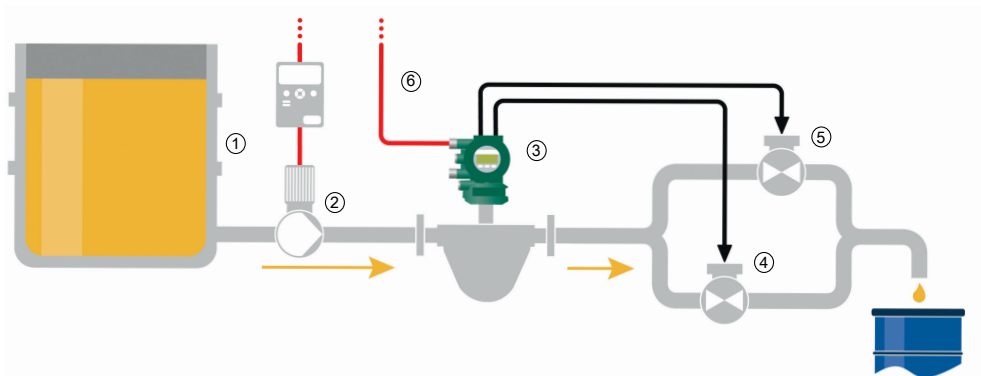

Fig. 46: Two-stage mode (The above diagram illustrates the fundamental functionality for one of several combination possibilities)

- | | |
|--------------------------|-------------|
| ① Storage tank | ④ Valve "A" |
| ② Pump | ⑤ Valve "B" |
| ③ Rotamass Total Insight | ⑥ HART |

For details about the ordering information, see *Batching function* [▶ 113].

8.3 Viscosity function

The Viscosity function allows the user to have an estimation of the viscosity of the fluid.

The function can be used as redundant viscosity control or as reference value to activate other processes like for instance fluid heating systems.

The viscosity estimation is calculated based on a comparison between measured pressure loss Δp and a “calculated” Δp_{cal} between two points of the pipe nearby the flow meter (refer to related instruction manual for the correct installation).

In order to use the function a pressure measurement device (separate order) directly connected to the analog input of the Rotamass Total Insight is necessary. Based on iteration process, Rotamass Total Insight finds the value of viscosity μ that returns a Δp_{cal} closed to the measured Δp .

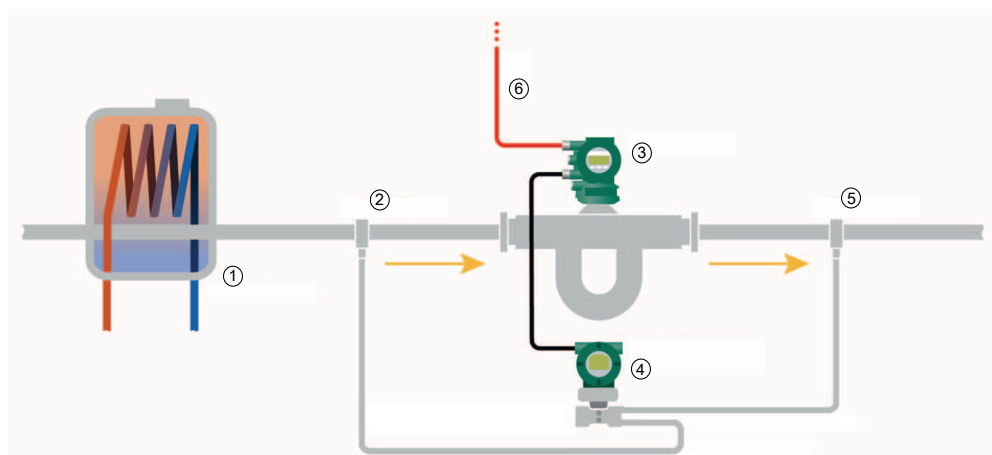

Fig. 47: Positioning of pressure taps

- | | | | |
|---|------------------------|---|-----------------------------------|
| ① | Heat exchanger | ④ | Differential pressure transmitter |
| ② | Pressure tap 1 | ⑤ | Pressure tap 2 |
| ③ | Rotamass Total Insight | ⑥ | HART |

Application example:

In this application example the Viscosity function returns a reference value used to activate a heating system and the Rotamass Total Insight is using HART communication.

For details about the ordering information, see *Viscosity function* [▶ 113].

8.4 Tube Health Check

General	<p>The Tube Health Check function is a valuable diagnostic function to evaluate the status of the measuring tubes of Rotamass Total Insight.</p> <p>For details about the ordering information, see <i>Tube Health Check</i> [▶ 117].</p>
Tube integrity	<p>The function is able to measure periodically the change of the stiffness of the measuring tubes and gives the possibility to set up a real predictive maintenance system or to detect corrosion or clogging of the measuring tubes. The measurement values can be stored in the internal microSD card or transmitted via HART, Modbus or PROFIBUS PA protocol and therefore integrated in the customers condition monitoring system.</p> <p>An alarm or an external event can be activated directly from Rotamass Total Insight in case the measured value exceeds a threshold defined by the user. The single measurements can be plotted in a diagram and printed in a report for quality and maintenance documentation by using the Yokogawa Device Management Software FieldMate.</p>
Dry Verification for Russia	<p>With Rotamass Total Insight and the Tube Health Check function customers in Russia can benefit from the Dry Verification procedure. The Dry Verification procedure is described in the verification method document (МП 208-053-2019). It determines the error of the flow measurement of the device. When Dry Verification test (tube stiffness change) results are within the required specifications it is not necessary to dispatch the flow meter to an external flow laboratory for verification. For Dry Verification please order Tube Health Check in combination with option VR.</p>

8.5 Measurement of heat quantity

The function allows to evaluate the total fuel calorific value of the measured fluid. The function can work with a constant value of the calorific value of the fluid, but in order to have a precise evaluation we suggest to use an additional device like a gas chromatograph (not included in the supply). The external device that supplies the instantaneous calorific value is connected with the current input of the transmitter. Based on the mass flow, the total calorific energy of the fluid is calculated as below:

Formula for total calorific energy

$$\sum E_{cal} = \sum (Q_m \times H_i \times \Delta t)$$

E_{cal}	Calorific energy
Q_m	Mass flow rate
H_i	Calorific value variable
Δt	Time interval between two measurements

Other formula based on volume and corrected volume are included in the function and can be set using the display or the configuration PC software FieldMate.

For details about the ordering information, see *Measurement of heat quantity* [▶ 118].

8.6 Features on Demand (FOD)

In combination with the “Ultimate” transmitter, the functions can be purchased and activated later as “Features on Demand”.

After the order, the user receives a KeyCode for input in the transmitter. To activate the desired functions, refer to related software instruction manual (IM01U10S0_-00_-R).

The options of FOD functions for Rotamass Total Insight are shown below.

To order these functions refer to the related general specifications for FOD functions (GS01U10B20-00_-R).

Option category	Options	Description	Valid from main SW rev. ¹⁾		
			Modbus	HART	PROFIBUS PA
Concentration and petroleum measurement	CST	Standard concentration measurement	R1.01.01	R1.01.02	R1.01.01
	AC0	Advanced concentration measurement, customer settings			
	C52	Net Oil Computing (NOC) following API standard			
Batching function	BT	Batching and filling function	-	R3.01.01	-
Viscosity function	VM	Viscosity computing function for liquids		R1.01.01	
Measurement of heat quantity	CGC	Measurement of the total transported energy content of a fuel in connection with a sensor for determining the fuel's calorific value (e.g. a gas chromatograph, not included in scope of delivery).	R1.01.01	R1.01.02	R1.01.01
Tube Health Check	TC	Tube Health Check	R1.01.01	R1.01.02 ²⁾	R1.01.01

¹⁾ Main software revision is given by the transmitter for which the FODs are intended for. For details refer to software instruction manual (IM01U10S0_-00_-R).

²⁾ From HART software rev. R3.01.01 Tube Health Check includes trend line report (by FieldMate) and the possibility to store the data on microSD card.

Please be sure that your device is compatible with the selected function and in case of doubts please contact Yokogawa Service Department providing the serial number or the model code of the target device.

9 Approvals and declarations of conformity

CE marking	The Rotamass Total Insight meets the statutory requirements of the applicable EU Directives. By attaching the CE mark, Rota Yokogawa confirms conformity of the field instrument with the requirements of the applicable EU Directives. The EU Declaration of Conformity is enclosed with the product on a data carrier.
RCM	Rotamass Total Insight meets the EMC requirements of the Australian Communications and Media Authority (ACMA).
Ex approvals	All data relevant for explosion protection are included in separate Explosion Proof Type Manuals.
NACE	<p>Chemical composition of wetted materials 316L/316/1.4404/1.4401/1.4435 and Ni-Alloy C-22/2.4602 is conform to:</p> <ul style="list-style-type: none">▪ ANSI / NACE-MR0175 / ISO15156-2▪ ANSI / NACE-MR0175 / ISO15156-3▪ NACE MR0103 <p>For details please see Rota Yokogawa declaration about NACE conformity 8660001.</p>
Pressure equipment approvals	<p>The Rotamass Total Insight is in compliance with the statutory requirements of the applicable EU Pressure Equipment Directive (PED) for fluid groups 1 and 2.</p> <p>The customer is fully responsible of selecting proper materials which withstand corrosive or erosive conditions. In case of heavy corrosion and/or erosion the instrument may not withstand the pressure and an incident may happen with human and/or environmental harm. Yokogawa will not take any liability regarding damage caused by corrosion or erosion. If corrosion or erosion may happen, the user has to check periodically if the necessary wall thickness is still in place.</p>
Functional safety	<p>The Rotamass Total Insight with HART communication type complies with the relevant safety management requirements of IEC 61508:2010 SIL3. The Rotamass Total Insight product families can be used to implement a SIL 2 safety function (with HFT = 0) or a SIL 3 safety function (with HFT = 1) with all its 4 – 20 mA outputs. The available number of outputs depends on the model code. For further information please contact Yokogawa sales department or visit:</p> <p>http://www.exida.com/SAEL-Safety/yokogawa-electric-corporation-rotamass-ti-series</p>

Tab. 28: Approvals and certifications

Type	Approval or certification
ATEX	<p>EU Directive 2014/34/EU</p> <p>ATEX approval:</p> <p>DEKRA 15ATEX0023 X</p> <p>CE₀₃₄₄ II2G or II2(1)G or II2D or II2(1)D</p> <p>Applied standards:</p> <ul style="list-style-type: none"> ▪ EN 60079-0 +A11 ▪ EN 60079-1 ▪ EN 60079-7 ▪ EN 60079-11 ▪ EN 60079-31
	<p>Remote transmitter (depending on the model code):</p> <p>Ex db [ia Ga] IIC T6 Gb or</p> <p>Ex db eb [ia Ga] IIC T6 Gb or</p> <p>Ex db [ia Ga] IIB T6 Gb or</p> <p>Ex db eb [ia Ga] IIB T6 Gb</p> <p>Ex db [ia Ga] [ia IIC Ga] IIB T6 Gb or</p> <p>Ex db eb [ia Ga] [ia IIC Ga] IIB T6 Gb or</p> <p>Ex tb [ia Da] IIIC T75 °C Db</p>
	<p>Remote sensor (depending on the model code):</p> <p>Ex ib IIC T6...T1 Gb or</p> <p>Ex ib IIB T6...T1 Gb</p> <p>Ex ib IIIC T150 °C Db or</p> <p>Ex ib IIIC T220 °C Db or</p> <p>Ex ib IIIC T350 °C Db</p>
	<p>Integral type (depending on the model code):</p> <p>Ex db ib IIC T6...T1 Gb or</p> <p>Ex db eb ib IIC T6...T1 Gb or</p> <p>Ex db ib IIB T6...T1 Gb or</p> <p>Ex db eb ib IIB T6...T1 Gb or</p> <p>Ex db ib [ia Ga] IIC T6...T1 Gb or</p> <p>Ex db eb ib [ia Ga] IIC T6...T1 Gb or</p> <p>Ex db ib [ia IIC Ga] IIB T6...T1 Gb or</p> <p>Ex db eb ib [ia IIC Ga] IIB T6...T1 Gb</p> <p>Ex ib tb IIIC T150 °C Db or</p> <p>Ex ib tb [ia Da] IIIC T150 °C Db</p>

Type	Approval or certification
IECEX	IECEx approval: IECEx DEK 15.0016X Applied standards: <ul style="list-style-type: none"> ▪ IEC 60079-0 ▪ IEC 60079-1 ▪ IEC 60079-7 ▪ IEC 60079-11 ▪ IEC 60079-31
	Remote transmitter (depending on the model code): Ex db [ja Ga] IIC T6 Gb or Ex db eb [ja Ga] IIC T6 Gb or Ex db [ja Ga] IIB T6 Gb or Ex db eb [ja Ga] IIB T6 Gb Ex db [ja Ga] [ja IIC Ga] IIB T6 Gb or Ex db eb [ja Ga] [ja IIC Ga] IIB T6 Gb or Ex tb [ja Da] IIIC T75 °C Db
	Remote sensor (depending on the model code): Ex ib IIC T6...T1 Gb or Ex ib IIB T6...T1 Gb Ex ib IIIC T150 °C Db or Ex ib IIIC T220 °C Db or Ex ib IIIC T350 °C Db
	Integral type (depending on the model code): Ex db ib IIC T6...T1 Gb or Ex db eb ib IIC T6...T1 Gb or Ex db ib IIB T6...T1 Gb or Ex db eb ib IIB T6...T1 Gb or Ex db ib [ja Ga] IIC T6...T1 Gb or Ex db eb ib [ja Ga] IIC T6...T1 Gb or Ex db ib [ja IIC Ga] IIB T6...T1 Gb or Ex db eb ib [ja IIC Ga] IIB T6...T1 Gb Ex ib tb IIIC T150 °C Db or Ex ib tb [ja Da] IIIC T150 °C Db

Type	Approval or certification
FM (CA/US)	<p>FM approvals:</p> <ul style="list-style-type: none"> ▪ US Cert No. FM16US0095X ▪ CA Cert No. FM16CA0031X <p>Applied standards:</p> <ul style="list-style-type: none"> ▪ Class 3600 ▪ Class 3610 ▪ Class 3615 ▪ Class 3810 ▪ Class 3616 ▪ NEMA 250 ▪ ANSI/IEC 60529 ▪ CSA-C22.2 No. 0-10 ▪ CSA-C22.2 No. 0.4-04 ▪ CSA-C22.2 No. 0.5-1982 ▪ CSA-C22.2 No. 94.1-07 ▪ CSA-C22.2 No. 94.2-07 ▪ CAN/CSA-C22.2 No. 60079-0 ▪ CAN/CSA-C22.2 No. 60079-11 ▪ CAN/CSA-C22.2 No. 61010-1-04 ▪ CSA-C22.2 No. 25-1966 ▪ CSA-C22.2 No. 30-M1986 ▪ CSA-C22.2 No. 60529
	<p>Remote transmitter (depending on the model code): CL I, DIV 1, GP ABCD, CL II/III, DIV 1, GP EFG; CL I ZN 1 GP IIC; Associated Apparatus CL I/II/III DIV 1, GP ABCDEFG; CL I ZN 0 GP IIC Entity Temperature class T6 or CL I, DIV 1, GP ABCD, CL II/III, DIV 1, GP EFG; CL I ZN 1 GP IIC; Associated Apparatus CL I/II/III DIV 1, GP ABCDEFG; CL I ZN 0 GP IIC Temperature class T6; Associated Apparatus CL I/II/III DIV 1, GP ABCDEFG; CL I ZN 0 GP IIC Entity Temperature class T6 or CL I, DIV 1, GP CD, CL II/III, DIV 1, GP EFG; CL I ZN 1 GP IIB; Associated Apparatus CL I/II/III DIV 1, GP CDEFG; CL I ZN 0 GP IIB Entity Temperature class T6 or CL I, DIV 1, GP CD, CL II/III, DIV 1, GP EFG; CL I ZN 1 GP IIB; Associated Apparatus CL I/II/III DIV 1, GP CDEFG; CL I ZN 0 GP IIB Temperature class T6; Associated Apparatus CL I/II/III DIV 1, GP ABCDEFG; CL I ZN 0 GP IIB Entity Temperature class T6</p>
	<p>Remote sensor (depending on the model code): IS CL I/II/III, DIV 1, GP ABCDEFG; CL I, ZN 0, GP IIC Temperature class T* or IS CL I/II/III, DIV 1, GP ABCDEFG; CL I, ZN 0, GP IIB Temperature class T*</p>

Type	Approval or certification
FM (CA/US)	Integral type (depending on the model code): CL I, DIV 1, GP ABCD, CL II/III, DIV 1, GP EFG; CL I ZN 1 GP IIC Temperature class T* or CL I, DIV 1, GP ABCD, CL II/III, DIV 1, GP EFG; CL I ZN 1 GP IIC Associated Apparatus CL I/II/III DIV 1 GP ABCDEFG; CL I ZN 0 GP IIC Entity Temperature class T* or CL I, DIV 1, GP CD, CL II/III, DIV 1, GP EFG; CL I ZN 1 GP IIB Temperature class T* or CL I, DIV 1, GP CD, CL II/III, DIV 1, GP EFG; CL I ZN 1 GP IIB Associated Apparatus CL I/II/III DIV 1 GP ABCDEFG; CL I ZN 0 GP IIC Entity Temperature class T*
INMETRO (BR)	INMETRO approval: DEKRA 16.0012X Applied standards: <ul style="list-style-type: none"> ▪ ABNT NBR IEC 60079-0 ▪ ABNT NBR IEC 60079-1 ▪ ABNT NBR IEC 60079-7 ▪ ABNT NBR IEC 60079-11 ▪ ABNT NBR IEC 60079-31 Remote transmitter (depending on the model code): Ex db [ia Ga] IIC T6 Gb or Ex db eb [ia Ga] IIC T6 Gb or Ex db [ia Ga] IIB T6 Gb or Ex db eb [ia Ga] IIB T6 Gb Ex db [ia Ga] [ia IIC Ga] IIB T6 Gb or Ex db eb [ia Ga] [ia IIC Ga] IIB T6 Gb or Ex tb [ia Da] IIIC T75 °C Db Remote sensor (depending on the model code): Ex ib IIC T6...T1 Gb or Ex ib IIB T6...T1 Gb Ex ib IIIC T150 °C Db or Ex ib IIIC T220 °C Db or Ex ib IIIC T350 °C Db Integral type (depending on the model code): Ex db ib IIC T6...T1 Gb or Ex db eb ib IIC T6...T1 Gb or Ex db ib IIB T6...T1 Gb or Ex db eb ib IIB T6...T1 Gb or Ex db ib [ia Ga] IIC T6...T1 Gb or Ex db eb ib [ia Ga] IIC T6...T1 Gb or Ex db ib [ia IIC Ga] IIB T6...T1 Gb or Ex db eb ib [ia IIC Ga] IIB T6...T1 Gb Ex ib tb IIIC T150 °C Db or Ex ib tb [ia Da] IIIC T150 °C Db

Type	Approval or certification
NEPSI (CN)	<p>Applied standards:</p> <ul style="list-style-type: none"> ▪ GB3836.1 ▪ GB3836.2 ▪ GB3836.3 ▪ GB3836.4 ▪ GB3836.19 ▪ GB3836.20
	<p>Remote transmitter (depending on the model code):</p> <p>Ex db [ia Ga] IIC T6 Gb or Ex db e [ia Ga] IIC T6 Gb or Ex db [ia Ga] IIB T6 Gb or Ex db e [ia Ga] IIB T6 Gb Ex db [ia Ga] [ia IIC Ga] IIB T6 Gb or Ex db e [ia Ga] [ia IIC Ga] IIB T6 Gb or Ex [iaD 20] tD A21 IP6X T75°C</p>
	<p>Remote sensor (depending on the model code):</p> <p>Ex ib IIC T6...T1 Gb or Ex ib IIB T6...T1 Gb Ex ibD 21 IP6X T150°C or Ex ibD 21 IP6X T220°C or Ex ibD 21 IP6X T350°C</p>
	<p>Integral type (depending on the model code):</p> <p>Ex db ib IIC T6...T1 Gb or Ex db e ib IIC T6...T1 Gb or Ex db ib IIB T6...T1 Gb or Ex db e ib IIB T6...T1 Gb or Ex db ib [ia Ga] IIC T6...T1 Gb or Ex db e ib [ia Ga] IIC T6...T1 Gb or Ex db ib [ia IIC Ga] IIB T6...T1 Gb or Ex db e ib [ia IIC Ga] IIB T6...T1 Gb Ex ibD 21 tD A21 IP6X T150°C or Ex [iaD 20] ibD 21 tD A21 IP6X T150°C</p>

Type	Approval or certification
<p>PESO (IN)</p>	<p>PESO approval: PESO approval is based on ATEX certification by DEKRA Certificate Number: DEKRA 15ATEX0023 X PESO approval is only valid for type of protection “d” flameproof enclosure. Option Q11 must be ordered for conformity of device with PESO requirements. Equipment Reference Numbers: P434956/_ P434884/_ P434885/_ P431901/_ P431875/_ P432033/_ P434983/_ P434957/_ P434887/_ Applied standards: <ul style="list-style-type: none"> ▪ EN 60079-0 +A11 ▪ EN 60079-1 ▪ EN 60079-11 Remote transmitter (depending on the model code): Ex db [ia Ga] IIC T6 Gb or Ex db [ia Ga] IIB T6 Gb or Ex db [ia Ga] [ia IIC Ga] IIB T6 Gb Remote sensor (depending on the model code): Ex ib IIC T6...T1 Gb or Ex ib IIB T6...T1 Gb Integral type (depending on the model code): Ex db ib IIC T6...T1 Gb or Ex db ib IIB T6...T1 Gb or Ex db ib [ia Ga] IIC T6...T1 Gb or Ex db ib [ia IIC Ga] IIB T6...T1 Gb</p>
<p>Safety Label (TW)</p>	<p>Please refer to IECEx approval for specifications. A device with IECEx approval (model code position 11, value: SF2_) must be ordered to comply with Safety Label requirements. For export to Taiwan and to get the Safety Label the Yokogawa representative in Taiwan must be contacted in advance. Identification Number: TD04000C</p>

Type	Approval or certification
Korea Ex	<p data-bbox="576 221 842 250">Korea Ex certificates:</p> <ul style="list-style-type: none"> <li data-bbox="596 257 842 286">▪ 18-KA4BO-0507X <li data-bbox="596 293 842 322">▪ 18-KA4BO-0508X <li data-bbox="596 329 842 358">▪ 18-KA4BO-0513X <li data-bbox="596 365 842 394">▪ 18-KA4BO-0526X <li data-bbox="596 400 842 430">▪ 18-KA4BO-0509X <li data-bbox="596 436 842 465">▪ 18-KA4BO-0510X <li data-bbox="596 472 842 501">▪ 18-KA4BO-0539X <li data-bbox="596 508 842 537">▪ 18-KA4BO-0540X <li data-bbox="596 544 842 573">▪ 18-KA4BO-0541X <li data-bbox="596 580 842 609">▪ 18-KA4BO-0681X <li data-bbox="596 616 842 645">▪ 18-KA4BO-0542X <li data-bbox="596 651 842 680">▪ 18-KA4BO-0682X <li data-bbox="596 687 842 716">▪ 18-KA4BO-0527X <li data-bbox="596 723 842 752">▪ 18-KA4BO-0528X <li data-bbox="596 759 842 788">▪ 18-KA4BO-0531X <li data-bbox="596 795 842 824">▪ 18-KA4BO-0532X <li data-bbox="596 831 842 860">▪ 18-KA4BO-0533X <li data-bbox="596 866 842 896">▪ 18-KA4BO-0534X <li data-bbox="596 902 842 931">▪ 18-KA4BO-0537X <li data-bbox="596 938 842 967">▪ 18-KA4BO-0538X <p data-bbox="576 1019 805 1048">Applied standards:</p> <p data-bbox="576 1055 1241 1084">Notice of Ministry of Labor No 2016-54 harmonized with</p> <ul style="list-style-type: none"> <li data-bbox="596 1090 778 1120">▪ IEC 60079-0 <li data-bbox="596 1126 778 1155">▪ IEC 60079-1 <li data-bbox="596 1162 778 1191">▪ IEC 60079-7 <li data-bbox="596 1198 791 1227">▪ IEC 60079-11 <li data-bbox="596 1234 791 1263">▪ IEC 60079-31

Type	Approval or certification
Korea Ex	Remote transmitter (depending on the model code): Ex d [ia] IIC T6 Ex d e [ia] IIC T6 Ex d [ia] IIB T6 Ex d e [ia] IIB T6 Ex d [ia] [ia IIC] IIB T6 Ex d e [ia] [ia IIC] IIB T6 Ex tb [ia] IIIC T75 °C
	Remote sensor (depending on the model code): Ex ib IIB T6...T1 Ex ib IIC T6...T1 Ex ib IIIC T150 °C Ex ib IIIC T220 °C Ex ib IIIC T350 °C
	Integral type (depending on the model code): Ex d ib IIC T6...T1 or Ex d e ib IIC T6...T1 or Ex d ib [ia] IIC T6...T1 or Ex d e ib [ia] IIC T6...T1 or Ex d ib IIB T6...T1 or Ex d e ib IIB T6...T1 Ex d ib [ia IIC] IIB T6...T1 or Ex d e ib [ia IIC] IIB T6...T1 or Ex ib tb IIIC T150 °C or Ex ib tb [ia] IIIC T150 °C

Type	Approval or certification
EAC Ex	Certificate Number: RU C-DE.AA71.B.00517 Applied standards: <ul style="list-style-type: none"> ▪ Gost 31610.0 (IEC 60079-0) ▪ Gost IEC 60079-1 ▪ Gost 31610.7 (IEC 60079-7) ▪ Gost 31610.11 (IEC 60079-11) ▪ Gost IEC 60079-31 ▪ Gost IEC 60079-14
	Remote transmitter (depending on the model code): 1Ex db [ia Ga] IIC T6 Gb X or 1Ex db e [ia Ga] IIC T6 Gb X or 1Ex db [ia Ga] IIB T6 Gb X or 1Ex db e [ia Ga] IIB T6 Gb X 1Ex db [ia Ga] [ia IIC Ga] IIB T6 Gb X or 1Ex db e [ia Ga] [ia IIC Ga] IIB T6 Gb X or 1Ex tb [ia Da] IIIC T75 °C Db X
	Remote sensor (depending on the model code): 1Ex ib IIC T6...T1 Gb X or 1Ex ib IIB T6...T1 Gb X 1Ex ib IIIC T150 °C Db X or 1Ex ib IIIC T220 °C Db X or 1Ex ib IIIC T350 °C Db X
Japan Ex	Integral type (depending on the model code): 1Ex db ib IIC T6...T1 Gb X or 1Ex db e ib IIC T6...T1 Gb X or 1Ex db ib IIB T6...T1 Gb X or 1Ex db e ib IIB T6...T1 Gb X or 1Ex db ib [ia Ga] IIC T6...T1 Gb X or 1Ex db e ib [ia Ga] IIC T6...T1 Gb X or 1Ex db ib [ia IIC Ga] IIB T6...T1 Gb X or 1Ex db e ib [ia IIC Ga] IIB T6...T1 Gb X 1Ex ib tb IIIC T150 °C Db X or 1Ex ib tb [ia Da] IIIC T150 °C Db X
	Japan Ex certificates: <ul style="list-style-type: none"> ▪ DEK 18.0052 X ▪ DEK 18.0059 X ▪ DEK 18.0068 X ▪ DEK 18.0077 X ▪ DEK 18.0086 X ▪ DEK 18.0087 X Applied standards: <ul style="list-style-type: none"> ▪ JNIOASH-TR-46-1 : 2015 ▪ JNIOASH-TR-46-2 : 2018 ▪ JNIOASH-TR-46-6 : 2015
	Remote transmitter (depending on the model code): Ex db [ia Ga] IIC T6 Gb Remote sensor (depending on the model code): Ex ib IIC T4...T2 Gb Integral type (depending on the model code): Ex db ib IIC T4...T3 Gb

Type	Approval or certification
Ingress protection	IP66/67 and NEMA 4X
EMC	EU directive 2014/30/EU per EN 61326-1 Class A Table 2 and EN 61326-2-3
	NAMUR NE21
	RCM in Australia/New Zealand
	KC mark in Korea
	TR CU 020 in EAEU area
LVD	EU directive 2014/35/EU per: <ul style="list-style-type: none"> ▪ EN 61010-1 ▪ EN 61010-2-030
	TR CU 004 in EAEU area
PED	EU directive 2014/68/EU per AD 2000 Code
	TR CU 032 in EAEU area
Marine	DNV GL Type approval according to DNVGL-CP-0338 for options MC2 and MC3
RoHS	EU directive 2011/65/EU per EN 50581
WEEE	EU directive 2012/19/EU (Waste Electrical and Electronic Equipment) is only valid in the European Economic Area. This instrument is intended to be sold and used only as a part of equipment which is excluded from the WEEE directive, such as large-scale stationary industrial tools, a large-scale fixed installation etc., and therefore it is in principle fully compliant with WEEE directive. The instrument should be disposed of in accordance with applicable national legislations or regulations, respectively.
SIL	Exida Certificate per IEC61508:2010 Parts 1-7 SIL 2 @ HFT=0; SIL 3 @ HFT =1
NAMUR	NAMUR NE95 compliant
Metrological Regulations	Rotamass Total Insight is registered as a measuring instrument in the following countries: <ul style="list-style-type: none"> ▪ China ▪ Russia ▪ Belarus Please contact your Yokogawa representative regarding respective “Pattern Approval Certificate of Measuring Instruments” and for export to these countries.
IGC	Intergranular Corrosion testing according to EN ISO 3651-2 and ASTM for option P6
ASME	ASME B31.3 compliance

10 Ordering information

10.1 Overview model code Giga 1F

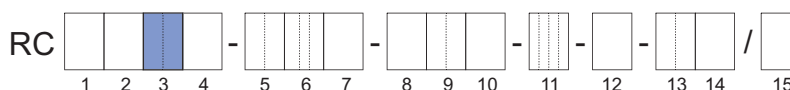

Model code position	1.	2.	3.	4.	5.	6.	7.	8.	9.	10.	11.	12.	13.	14.	Description	Restrictions	
Transmitter	E														Essential (base function)	not with accuracy C5, 50 not with communication type and I/O JH, JJ, JK, JL, JM, JN, M2, M7, G_	
	U														Ultimate (high function)	not with accuracy 70 not with display 0	
	N														Spare sensor without transmitter, combinable with Rotamass TI transmitter	see restrictions below	
Sensor	G														Giga	–	
Meter size	1F														Nominal mass flow : 250 t/h (9200 lb/min) Maximum mass flow: 300 t/h (11000 lb/min)	–	
Material wetted parts	S														Stainless steel 1.4404/316L	–	
	H														Ni alloy C-22/2.4602	not with option RT, RTA, MC_, FE, P2_, NL, CL	
Process connection size	1H														DN100, 4"	only material wetted parts S	
	1Q														DN125, 5"	–	
	1F														DN150, 6"	only process connection type ASME, EN	
Process connection type	BA1														ASME flange class 150, suitable for ASME B16.5, raised face (RF)	see tables on page [43] and the following page	
	BA2														ASME flange class 300, suitable for ASME B16.5, raised face (RF)		
	BA4														ASME flange class 600, suitable for ASME B16.5, raised face (RF)		
	CA4														ASME flange class 600, suitable for ASME B16.5, ring joint (RJ)		
	BD2														EN flange PN 16, suitable for EN 1092-1 type B1, raised face (RF)	not with option WPA, RTA, PTA, P2_ see tables on page [45] and the following pages for option CL, NL see tables on page [50]	
	ED2														EN flange PN 16, suitable for EN 1092-1 type E, spigot		
	FD2														EN flange PN 16, suitable for EN 1092-1 type F, recess		
	GD2														EN flange PN 16, suitable for EN 1092-1 type D, groove		
	BD4														EN flange PN 40, suitable for EN 1092-1 type B1, raised face (RF)		
	ED4														EN flange PN 40, suitable for EN 1092-1 type E, spigot		
	FD4														EN flange PN 40, suitable for EN 1092-1 type F, recess		
	GD4														EN flange PN 40, suitable for EN 1092-1 type D, groove		
	BD5														EN flange PN 63, suitable for EN 1092-1 type B1, raised face (RF)		
	ED5														EN flange PN 63, suitable for EN 1092-1 type E, spigot		
	FD5														EN flange PN 63, suitable for EN 1092-1 type F, recess		
	GD5														EN flange PN 63, suitable for EN 1092-1 type D, groove		
	BD6														EN flange PN 100, suitable for EN 1092-1 type B1, raised face (RF)		
	ED6														EN flange PN 100, suitable for EN 1092-1 type E, spigot		
FD6														EN flange PN 100, suitable for EN 1092-1 type F, recess			
GD6														EN flange PN 100, suitable for EN 1092-1 type D, groove			
Sensor housing material	0														Stainless steel 1.4301/304, 1.4404/316L		–
	1														Stainless steel 1.4404/316L		not with option SA, JF53, JF54

Model code position	1.	2.	3.	4.	5.	6.	7.	8.	9.	10.	11.	12.	13.	14.	Description	Restrictions
Process fluid temperature range									0						Standard, integral type: -50 – 150 °C (-58 – 302 °F), remote type: -70 – 150 °C (-94 – 302 °F)	not with Ex Approval JF52
									2						Mid-range: -70 – 230 °C (-94 – 446 °F)	not with design and housing 0, 2, A, E, J not with Ex Approval JF53, JF54 not with option RB, MC_
									3						High: 0 – 350 °C (32 – 662 °F)	not with design and housing 0, 2, A, E, J not with Ex Approval JF52, JF53, JF54 not with option RB, MC_
Mass flow and density accuracy									E7						Liquid: 0.2 % maximum mass flow deviation D_{rat} , 4 g/l density deviation	not with transmitter N
									C5						Liquid: 0.1 % maximum mass flow deviation D_{rat} , 2 g/l density deviation	not with transmitter E
									70						Gas: 0.75% maximum mass flow deviation D_{rat}	only with transmitter E
									50						Gas: 0.5% maximum mass flow deviation D_{rat}	not with transmitter E not with option CST, AC_, C52, VM
Design and housing									0						Integral type with "urethane-cured polyester powder coating" coated aluminum transmitter housing	not with process fluid temperature range 2, 3, Ex approval JF52, communication type and I/O NN
									2						Integral type with "corrosion protection coating" coated aluminum transmitter housing	not with option T_., L_., MC_, Y_.
									A						Remote type with "urethane-cured polyester powder coating" coated aluminum transmitter housing and standard neck sensor	not with process fluid temperature range 2, 3, Ex approval JF52 not with option RB, T_.
									B						Remote type with "urethane-cured polyester powder coating" coated aluminum transmitter housing and long neck sensor	not with option RB
									E						Remote type with "corrosion protection coating" coated aluminum transmitter housing and standard neck sensor	not with process fluid temperature range 2, 3, Ex approval JF52 not with option RB, T_.
									F						Remote type with "corrosion protection coating" coated aluminum transmitter housing and long neck sensor	not with option RB
									J						Remote type stainless steel transmitter and standard neck sensor	not with process fluid temperature range 2, 3 not with Ex approval KF21, SF21, GF21, UF21, NF21, PF21, JF5_ not with option RB, T_.
									K						Remote type stainless steel transmitter and long neck sensor	not with Ex approval KF21, SF21, GF21, UF21, NF21, PF21, JF5_ not with option RB

Model code position	1.	2.	3.	4.	5.	6.	7.	8.	9.	10.	11.	12.	13.	14.	Description	Restrictions
Ex approval											NN00				None	not with communication type and I/O JP, JQ, JR, JS
											KF21				ATEX, explosion group IIC and IIIC	not with design and housing J, K
											KF22				ATEX, explosion group IIB and IIIC	–
											SF21				IECEX, explosion group IIC and IIIC	not with design and housing J, K
											SF22				IECEX, explosion group IIB and IIIC	
											GF21				EAC Ex, explosion group IIC and IIIC	not with design and housing J, K only with option VB, VE or VR
											GF22				EAC Ex, explosion group IIB and IIIC	only with option VB, VE or VR
											FF11				FM, groups A, B, C, D, E, F, G	not with transmitter N, cable entries 4, communication type and I/O G_
											FF12				FM, groups C, D, E, F, G	not with option KC, VB, VE, VR, Y_ _ _
											UF21				INMETRO, explosion group IIC and IIIC	not with design and housing J, K
											UF22				INMETRO, explosion group IIB and IIIC	
											NF21				NEPSI, explosion group IIC and IIIC	not with design and housing J, K only with option CN
											NF22				NEPSI, explosion group IIB and IIIC	only with option CN
											PF21				Korea Ex, explosion group IIC and IIIC	not with design and housing J, K only with option KC
											PF22				Korea Ex, explosion group IIB and for integral type also IIIC	only with option KC
											JF52				Japan Ex, Temperature class T2, explosion group IIC	not with transmitter N, process fluid temperature range 0,3, design and housing 0, 2, A, E, J, K, cable entries 2, communication type and I/O JP, JQ, JR, JS, G1, display 0 only with option PJ and V52 or V53 not with option Y_ _ _
											JF53				Japan Ex, Temperature class T3, explosion group IIC	not with transmitter N, sensor housing material 1, process fluid temperature range 2,3, design and housing J, K, cable entries 2, communication type and I/O JP, JQ, JR, JS, G1, display 0
											JF54				Japan Ex, Temperature class T4, explosion group IIC	only with option PJ and V52 or V53 not with option Y_ _ _
	Cable entries												2		ANSI ½" NPT	not with Ex approval JF5_
													4		ISO M20x1.5	not with Ex approval FF11, FF12

Model code position	1.	2.	3.	4.	5.	6.	7.	8.	9.	10.	11.	12.	13.	14.	Description	Restrictions	
Communication type and I/O													JA		1 active current output HART, 1 passive pulse or status output	not with option CGC, VM	
													JB		2 active current outputs one with HART, 2 passive pulse or status outputs		
													JC		2 active current outputs one with HART, 1 passive pulse or status output, 1 voltage-free status input		
													JD		1 active current output HART, 2 passive pulse or status outputs, 1 passive status output		
													JE		1 active current output HART, 2 passive pulse or status outputs, 1 voltage-free status input		
													JF		1 active current output HART, 1 passive pulse or status output, 1 active pulse or status output with pull-up resistor, 1 voltage-free status input		
													JG		1 active current output HART, 1 passive pulse or status output, 1 active pulse or status output, 1 voltage-free status input		
														JH		1 active current output HART, 1 passive pulse or status output, 1 passive current output, 1 active current input	not with transmitter E
														JJ		1 active current output HART, 2 passive pulse or status outputs, 1 active current input	
														JK		1 active current output HART, 1 passive pulse or status output, 1 voltage-free status input, 1 active current input	
														JL		1 active current output HART, 1 passive pulse or status output, 1 passive current output, 1 passive current input	
														JM		1 active current output HART, 2 passive pulse or status outputs, 1 passive current input	
														JN		1 active current output HART, 1 passive pulse or status output, 1 voltage-free status input, 1 passive current input	

Model code position	1.	2.	3.	4.	5.	6.	7.	8.	9.	10.	11.	12.	13.	14.	Description	Restrictions
Communication type and I/O													JP		2 passive current outputs one with HART, 1 passive pulse or status output	
													JQ		2 passive current outputs one with HART, 2 passive pulse or status outputs	not with Ex approval NN00, JF5_
													JR		2 passive current outputs one with HART, 1 passive NAMUR pulse or status output	not with option CGC, MC_, VM
													JS		2 passive current outputs one with HART, 2 passive NAMUR pulse or status outputs	
													M0		Modbus output, 1 passive pulse or status output	not with option CGC, PS, BT, VM
													M2		Modbus output, 1 passive pulse or status output, 1 active current input	not with transmitter E not with option PS, BT, VM
													M3		Modbus output, 2 passive pulse or status outputs	
													M4		Modbus output, 1 passive pulse or status output, 1 active pulse or status output	not with option CGC, PS, BT, VM
													M5		Modbus output, 1 passive pulse or status output, 1 active pulse or status output with pull-up resistor	
													M6		Modbus output, 1 passive pulse or status output, 1 active current output	
													M7		Modbus output, 1 passive pulse or status output, 1 passive current input	not with transmitter E not with option PS, BT, VM
													G0		PROFIBUS PA, 1 passive pulse output	not with transmitter E not with Ex Approval FF11, FF12 not with option PS, BT, MC_
													G1		PROFIBUS PA, intrinsically safe, 1 passive pulse output	not with transmitter E not with Ex Approval NN00, FF11, FF12, JF5_ not with option PS, Q11, BT, MC_
												NN		Spare sensor without transmitter, all communication types and I/Os apply	only with transmitter N not with design and housing 0, 2, Ex Approval FF11, FF12, JF5_ not with option VB, VR	
Display													0		No display	only with transmitter E not with option JF5_
													1		With display	not with transmitter N
													N		Spare sensor without transmitter, no display applied	only with transmitter N not with Ex Approval FF11, FF12, JF5_ not with option VB, VR

10.2 Overview model code Giga 2H

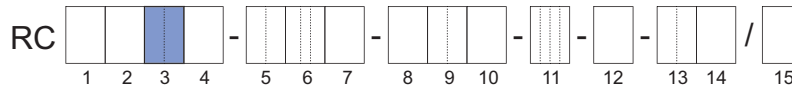

Model code position	1.	2.	3.	4.	5.	6.	7.	8.	9.	10.	11.	12.	13.	14.	Description	Restrictions
Transmitter	E														Essential (base function)	not with accuracy C5, 50 not with communication type and I/O JH, JJ, JK, JL, JM, JN, M2, M7, G_
	U														Ultimate (high function)	not with accuracy 70 not with display 0
	N														Spare sensor without transmitter, combinable with Rotamass TI transmitter	see restrictions below
Sensor	G														Giga	-
Meter size	2H														Nominal mass flow : 500 t/h (18000 lb/min) Maximum mass flow: 600 t/h (22000 lb/min)	not with option T_..., P15, MC_, NL, CL
Material wetted parts	S														Stainless steel 1.4404/316L	-
Process connection size	1F														DN150, 6"	-
	2H														DN200, 8"	-
Process connection type	BA1														ASME flange class 150, suitable for ASME B16.5, raised face (RF)	see tables on page [43] and following page
	BA2														ASME flange class 300, suitable for ASME B16.5, raised face (RF)	
	BA4														ASME flange class 600, suitable for ASME B16.5, raised face (RF)	
	CA4														ASME flange class 600, suitable for ASME B16.5, ring joint (RJ)	
	BD2														EN flange PN 16, suitable for EN 1092-1 type B1, raised face (RF)	not with option WPA, RTA, PTA, P2_
	ED2														EN flange PN 16, suitable for EN 1092-1 type E, spigot	
	FD2														EN flange PN 16, suitable for EN 1092-1 type F, recess	
	GD2														EN flange PN 16, suitable for EN 1092-1 type D, groove	
	BD4														EN flange PN 40, suitable for EN 1092-1 type B1, raised face (RF)	
	ED4														EN flange PN 40, suitable for EN 1092-1 type E, spigot	
	FD4														EN flange PN 40, suitable for EN 1092-1 type F, recess	
	GD4														EN flange PN 40, suitable for EN 1092-1 type D, groove	
	BD5														EN flange PN 63, suitable for EN 1092-1 type B1, raised face (RF)	
	ED5														EN flange PN 63, suitable for EN 1092-1 type E, spigot	
	FD5														EN flange PN 63, suitable for EN 1092-1 type F, recess	
GD5														EN flange PN 63, suitable for EN 1092-1 type D, groove		
Sensor housing material	0														Stainless steel 1.4301/304, 1.4404/316L	-
	1														Stainless steel 1.4404/316L	not with option SA, JF53, JF54
Process fluid temperature range	0														Standard, integral type: -50 – 150 °C (-58 – 302 °F), remote type: -70 – 150 °C (-94 – 302 °F)	not with Ex Approval JF52
	2														Mid-range: -70 – 230 °C (-94 – 446 °F)	not with design and housing 0, 2, A, E, J not with Ex Approval JF53, JF54 not with option RB
	3														High: 0 – 350 °C (32 – 662 °F)	not with design and housing 0, 2, A, E, J not with Ex Approval JF52, JF53, JF54 not with option RB
Mass flow and density accuracy	E7														Liquid: 0.2 % maximum mass flow deviation D_{flat} , 4 g/l density deviation	not with transmitter N
	C5														Liquid: 0.1 % maximum mass flow deviation D_{flat} , 2 g/l density deviation	not with transmitter E
	70														Gas: 0.75% maximum mass flow deviation D_{flat}	only with transmitter E
	50														Gas: 0.5% maximum mass flow deviation D_{flat}	not with transmitter E not with option CST, AC_, C52, VM

Model code position	1.	2.	3.	4.	5.	6.	7.	8.	9.	10.	11.	12.	13.	14.	Description	Restrictions
Design and housing										0					Integral type with "urethane-cured polyester powder coating" coated aluminum transmitter housing	not with process fluid temperature range 2, 3, Ex approval JF52, communication type and I/O NN
										2					Integral type with "corrosion protection coating" coated aluminum transmitter housing	not with option L____, Y____
										A					Remote type with "urethane-cured polyester powder coating" coated aluminum transmitter housing and standard neck sensor	not with process fluid temperature range 2, 3, Ex approval JF52 not with option RB
										B					Remote type with "urethane-cured polyester powder coating" coated aluminum transmitter housing and long neck sensor	not with option RB
										E					Remote type with "corrosion protection coating" coated aluminum transmitter housing and standard neck sensor	not with process fluid temperature range 2, 3, Ex approval JF52 not with option RB
										F					Remote type with "corrosion protection coating" coated aluminum transmitter housing and long neck sensor	not with option RB
										J					Remote type stainless steel transmitter and standard neck sensor	not with process fluid temperature range 2, 3 not with Ex approval KF21, SF21, GF21, UF21, NF21, PF21, JF5_ not with option RB
										K					Remote type stainless steel transmitter and long neck sensor	not with Ex approval KF21, SF21, GF21, UF21, NF21, PF21, JF5_ not with option RB
Ex approval										NN00					None	not with communication type and I/O JP, JQ, JR, JS
										KF21					ATEX, explosion group IIC and IIIC	not with design and housing J, K
										KF22					ATEX, explosion group IIB and IIIC	–
										SF21					IECEX, explosion group IIC and IIIC	not with design and housing J, K
										SF22					IECEX, explosion group IIB and IIIC	
										GF21					EAC Ex, explosion group IIC and IIIC	not with design and housing J, K only with option VB, VE or VR
										GF22					EAC Ex, explosion group IIB and IIIC	only with option VB, VE or VR
										FF11					FM, groups A, B, C, D, E, F, G	not with transmitter N, cable entries 4, communication type and I/O G_ not with option KC, VB, VE, VR, Y____
										FF12					FM, groups C, D, E, F, G	
										UF21					INMETRO, explosion group IIC and IIIC	not with design and housing J, K
										UF22					INMETRO, explosion group IIB and IIIC	
										NF21					NEPSI, explosion group IIC and IIIC	not with design and housing J, K only with option CN
										NF22					NEPSI, explosion group IIB and IIIC	only with option CN
										PF21					Korea Ex, explosion group IIC and IIIC	not with design and housing J, K only with option KC
										PF22					Korea Ex, explosion group IIB and for integral type also IIIC	only with option KC
										JF52					Japan Ex, Temperature class T2, explosion group IIC	not with transmitter N, process fluid temperature range 0.3, design and housing 0, 2, A, E, J, K, cable entries 2, communication type and I/O JP, JQ, JR, JS, G1, display 0 only with option PJ and V52 or V53 not with option Y____
										JF53					Japan Ex, Temperature class T3, explosion group IIC	not with transmitter N, sensor housing material 1, process fluid temperature range 2,3, design and housing J, K, cable entries 2, communication type and I/O JP, JQ, JR, JS, G1, display 0
										JF54					Japan Ex, Temperature class T4, explosion group IIC	only with option PJ and V52 or V53 not with option Y____

Model code position	1.	2.	3.	4.	5.	6.	7.	8.	9.	10.	11.	12.	13.	14.	Description	Restrictions
Cable entries												2		ANSI ½" NPT	not with Ex approval JF5_	
												4		ISO M20x1.5	not with Ex approval FF11, FF12	
Communication type and I/O													JA	1 active current output HART, 1 passive pulse or status output	not with option CGC, VM	
													JB	2 active current outputs one with HART, 2 passive pulse or status outputs		
													JC	2 active current outputs one with HART, 1 passive pulse or status output, 1 voltage-free status input		
													JD	1 active current output HART, 2 passive pulse or status outputs, 1 passive status output		
													JE	1 active current output HART, 2 passive pulse or status outputs, 1 voltage-free status input		
													JF	1 active current output HART, 1 passive pulse or status output, 1 active pulse or status output with pull-up resistor, 1 voltage-free status input		
													JG	1 active current output HART, 1 passive pulse or status output, 1 active pulse or status output, 1 voltage-free status input		
													JH	1 active current output HART, 1 passive pulse or status output, 1 passive current output, 1 active current input	not with transmitter E	
													JJ	1 active current output HART, 2 passive pulse or status outputs, 1 active current input		
													JK	1 active current output HART, 1 passive pulse or status output, 1 voltage-free status input, 1 active current input		
													JL	1 active current output HART, 1 passive pulse or status output, 1 passive current output, 1 passive current input		
													JM	1 active current output HART, 2 passive pulse or status outputs, 1 passive current input		
													JN	1 active current output HART, 1 passive pulse or status output, 1 voltage-free status input, 1 passive current input		

Model code position	1.	2.	3.	4.	5.	6.	7.	8.	9.	10.	11.	12.	13.	14.	Description	Restrictions
Communication type and I/O													JP		2 passive current outputs one with HART, 1 passive pulse or status output	
													JQ		2 passive current outputs one with HART, 2 passive pulse or status outputs	not with Ex approval NN00, JF5_
													JR		2 passive current outputs one with HART, 1 passive NAMUR pulse or status output	not with option CGC, VM
													JS		2 passive current outputs one with HART, 2 passive NAMUR pulse or status outputs	
													M0		Modbus output, 1 passive pulse or status output	not with option CGC, PS, BT, VM
													M2		Modbus output, 1 passive pulse or status output, 1 active current input	not with transmitter E not with option PS, BT, VM
													M3		Modbus output, 2 passive pulse or status outputs	
													M4		Modbus output, 1 passive pulse or status output, 1 active pulse or status output	not with option CGC, PS, BT, VM
													M5		Modbus output, 1 passive pulse or status output, 1 active pulse or status output with pull-up resistor	
													M6		Modbus output, 1 passive pulse or status output, 1 active current output	
													M7		Modbus output, 1 passive pulse or status output, 1 passive current input	not with transmitter E not with option PS, BT, VM
													G0		PROFIBUS PA, 1 passive pulse output	not with transmitter E not with Ex Approval FF11, FF12 not with option PS, VB, BT
													G1		PROFIBUS PA, intrinsically safe, 1 passive pulse output	not with transmitter E not with Ex Approval NN00, FF11, FF12, JF5_ not with option PS, VB, Q11, BT
												NN		Spare sensor without transmitter, all communication types and I/Os apply	only with transmitter N not with design and housing 0, 2, Ex Approval FF11, FF12, JF5_ not with option VB, VR	
Display													0		No display	only with transmitter E not with option JF5_
													1		With display	not with transmitter N
													N		Spare sensor without transmitter, no display applied	only with transmitter N not with Ex Approval FF11, FF12, JF5_ not with option VB, VR

10.3 Overview options

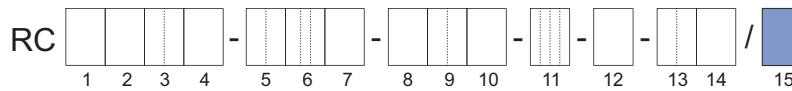

Option category	Options	Description	Restriction
Additional nameplate information	BG	Nameplate with customer device location identification	–
Presetting of customer parameters	PS	Presetting according to customer parameters	not with transmitter N, communication type and I/O G_, M_
Country-specific delivery	PJ	Delivery to Japan incl. SI units pre-setting and Quality Inspection Certificate (EN/JP)	–
	CN	Delivery to China including China RoHS mark	
	KC	Delivery to Korea including KC mark	not with Ex Approval FF1_
	VE	Delivery to EAEU area including EAC mark	
	VB	Delivery to EAEU area including EAC mark and Belarus Pattern Approval mark	not with transmitter N, Ex Approval FF1_, communication type and I/O G_
Country-specific application	VR	Delivery to EAEU area including EAC mark and Russia Pattern Approval mark	not with Ex Approval FF1_
	Q11	PESO approval delivery	only with Ex Approval KF2_ not with communication type and I/O G1
Concentration and petroleum measurement	QR	Primary calibration valid in Russia, including certificate	only with option VR not with transmitter N
	AC0	Advanced concentration measurement, customer settings	only with transmitter U not with mass flow and density accuracy 70, 50
	AC1	Advanced concentration measurement, one default data set	
	AC2	Advanced concentration measurement, two default data sets	
	AC3	Advanced concentration measurement, three default data sets	
	AC4	Advanced concentration measurement, four default data sets	
CST	Standard concentration measurement		
Rupture disc	C52	Net Oil Computing (NOC) following API standard	
	RD	Rupture disc	not with option T_ _

Option category	Options	Description	Restriction
Mass flow calibration	K2	Customer-specific 5-point mass flow calibration with measuring range on factory calibration certificate (mass flow or volume flow of water). A table listing the desired calibration points must be supplied with the order.	-
	K5	Customer-specific 10-point mass flow calibration with measuring range on DAkkS calibration certificate (mass flow or volume flow of water). A table listing the desired calibration points must be supplied with the order.	
Accordance with terms of order	P2	Declaration of compliance with the order 2.1 according to EN 10204	
	P3	Quality Inspection Certificate (Inspection Certificate 3.1 according to EN 10204)	not with option P10, P11, P12, P13, P21, P22
Material certificates	P6	Certificate of Marking Transfer and Raw Material Certificates (Inspection Certificate 3.1 according to EN 10204), including IGC and conform to NACE MR0175 and MR0103	not with option P10, P11, P12, P13, P21, P22
Pressure testing	P8	Hydrostatic Pressure Test Certificate (Inspection Certificate 3.1 according to EN 10204)	not with option P10, P12, P13, P14, P21
Surfaces free of oil and grease	H1	Degreasing of wetted surfaces according to ASTM G93-03 (Level C), including test report	-
Welding certificates	WP	WPS according to DIN EN ISO 15609-1	not with option P13, P14, P15, P2_
		WPQR according to DIN EN ISO 15614-1	
	WQC according to DIN EN 287-1 or DIN EN ISO 6906-4		
	WPA	Welding procedures and Certificate according to ASME IX	only with process connection type BA_ or CA_ not with option P12, P13, P14, P2_
Calibration certificate	L2	The certificate confirms that the delivered instrument has undergone a calibration traceable to national standards, including a list of working standards used for calibration. Language: English/Japanese	not with transmitter N
	L3	The certificate confirms that the delivered instrument has undergone a calibration traceable to national standards, including a list of primary standards to which the delivered product is traceable. Language: English/Japanese	
	L4	The certificate confirms that the delivered instrument has undergone a calibration traceable to national standards and that the calibration system of Rota Yokogawa is traceable to national standards. Language: English/Japanese	

Option category	Options	Description	Restriction
X-ray inspection of flange weld seam	RT	X-ray inspection of flange weld seam according to DIN EN ISO 17636-1/B Evaluation according to AD 2000 HP 5/3 and DIN EN ISO 5817/C, including certificate	not with material wetted parts H not with option P15, P2_
	RTA	X-ray test according to ASME V	not with material wetted parts H only with process connection type BA_ or CA_ not with option P12, P13, P14, P2_
Dye penetrant test of weld seams	PT	Dye penetrant test of process connection weld seams according to DIN EN ISO 3452-1, including certificate	not with option P12, P13, P15, P2_
	PTA	Dye penetrant test of flange welding according to ASME V, including certificate	only with process connection type BA_ or CA_ not with option P12, P13, P14, P2_
Ferrite testing	FE	Ferrite test for flange welding acc. DIN EN ISO 8249	not with material wetted parts H
Transmitter housing rotated 180°	RB	Alignment of transmitter housing rotated 180°	not with transmitter N, design and housing A, B, E, F, J, K, process fluid temperature range 2, 3 not with option T_
Insulation and heat tracing	T10	Insulation	not with design and housing 0, 2, A, E, J not with meter size 2H not with option RD, RB, P15, MC_
	T21	Insulation and heat tracing, 1/2" ASME class 150, raised face (RF)	
	T22	Insulation and heat tracing, 1/2" ASME class 300, raised face (RF)	
	T26	Insulation and heat tracing, EN DN15, PN40	
	T31	Insulation, heat tracing with ventilation, 1/2" ASME class 150, raised face (RF)	
	T32	Insulation, heat tracing with ventilation, 1/2" ASME class 300, raised face (RF)	
Measurement of heat quantity	CGC	Measurement of the total transported energy content of a fuel in connection with a sensor for determining the fuel's calorific value (e.g. a gas chromatograph, not included in scope of delivery)	only with transmitter U only with communication type and I/O JH, JJ, JK, JL, JM, JN, M2, M7, G_

Option category	Options	Description	Restriction
Connecting cable type and length	L000	without standard connecting cable	not with transmitter N not with design and housing 0, 2 not with option MC_
	L005	5 meter (16.4 ft) remote connecting cable terminated std. gray / Ex blue	
	L010	10 meter (32.8 ft) remote connecting cable terminated std. gray / Ex blue	
	L015	15 meter (49.2 ft) remote connecting cable terminated std. gray / Ex blue	
	L020	20 meter (65.6 ft) remote connecting cable terminated std. gray / Ex blue	
	L030	30 meter (98.4 ft) remote connecting cable terminated std. gray / Ex blue	
Connecting cable type and length	Y000	without fire retardant connecting cable	not with design and housing 0, 2 not with Ex approval FF_-, JF5_
	Y005	5 meter (16.4 ft) remote fire retardant connecting cable not terminated	not with transmitter N not with design and housing 0, 2 not with Ex approval FF_-, JF5_
	Y010	10 meter (32.8 ft) remote fire retardant connecting cable not terminated	
	Y015	15 meter (49.2 ft) remote fire retardant connecting cable not terminated	
	Y020	20 meter (65.6 ft) remote fire retardant connecting cable not terminated	
	Y030	30 meter (98.4 ft) remote fire retardant connecting cable not terminated	
Marine Approval	MC2	Marine approval according to DNV GL piping class 2	
	MC3	Marine approval according to DNV GL piping class 3	

Option category	Options	Description	Restriction
Combined certificate	P10	Combination of: <ul style="list-style-type: none"> ▪ P3: Quality Inspection Certificate ▪ P6: Certificate of Marking Transfer and Raw Material Certificates ▪ P8: Hydrostatic Pressure Test Certificate 	not with option P3, P6, P8
	P11	Combination of: <ul style="list-style-type: none"> ▪ P3: Quality Inspection Certificate ▪ P6: Certificate of Marking Transfer and Raw Material Certificates ▪ PM: Positive Material Identification of wetted parts 	not with option P3, P6, PM
	P12	Combination of: <ul style="list-style-type: none"> ▪ P3: Quality Inspection Certificate ▪ P6: Certificate of Marking Transfer and Raw Material Certificates ▪ PT: Dye penetrant test according to DIN EN ISO 3452-1 ▪ P8: Hydrostatic Pressure Test Certificate 	not with option P3, P6, P8, P15, PT, WPA, RTA, PTA
	P13	Combination of: <ul style="list-style-type: none"> ▪ P3: Quality Inspection Certificate ▪ P6: Certificate of Marking Transfer and Raw Material Certificates ▪ PT: Dye penetrant test according to DIN EN ISO 3452-1 ▪ PM: Positive Material Identification of wetted parts ▪ P8: Hydrostatic Pressure Test Certificate ▪ WP: Welding certificates 	not with option P3, P6, P8, P15, WP, PM, PT, WPA, RTA, PTA
	P14	Combination of: <ul style="list-style-type: none"> ▪ PM: Positive Material Identification of wetted parts ▪ P8: Hydrostatic Pressure Test Certificate ▪ WP: Welding certificates 	not with option P8, P15, WP, PM, WPA, RTA, PTA

Option category	Options	Description	Restriction
Combined certificate	P20	Combination of: <ul style="list-style-type: none"> ▪ PTA: Dye penetrant test of flange welding according to ASME V ▪ WPA: Welding procedures and Certificates according to ASME IX ▪ RTA: X-ray test according to ASME V 	not with material wetted parts H not with option WP, WPA, RT, RTA, PT, PTA only with process connection type BA_ or CA_
	P21	Combination of: <ul style="list-style-type: none"> ▪ P3: Quality Inspection Certificate ▪ P6: Certificate of Marking Transfer and Raw Material Certificates ▪ P8: Hydrostatic Pressure Test Certificate ▪ PTA: Dye penetrant test of flange welding according ASME V ▪ WPA: Welding procedures and Certificates according to ASME IX ▪ RTA: X-ray test according to ASME V 	not with material wetted parts H only with process connection type BA_ or CA_ not with option P3, P6, P8, WP, WPA, RT, RTA, PT, PTA
	P22	Combination of: <ul style="list-style-type: none"> ▪ P3: Quality Inspection Certificate ▪ P6: Certificate of Marking Transfer and Raw Material Certificates ▪ PM: Positive Material Identification of wetted parts ▪ PTA: Dye penetrant test of flange welding according ASME V ▪ WPA: Welding procedures and Certificates according to ASME IX ▪ RTA: X-ray test according to ASME V 	not with material wetted parts H only with process connection type BA_ or CA_ not with option P3, P6, WP, WPA, RT, RTA, PM, PT, PTA
Positive Material Identification of wetted parts	PM	Positive Material Identification of wetted parts, including certificate (Inspection Certificate 3.1 according to EN 10204)	not with option P11, P13, P14, P22
Tube Health Check	TC	Tube Health Check	not with transmitter N
ASME B31.3 compliance	P15	ASME B31.3 compliance NORMAL FLUID SERVICE	not with meter size 2H only with process connection type BA_ CA_ not with option WP, RT, PT, P12, P13, P14, T_
Batching function	BT	Batching and filling function	only with transmitter U and communication type and I/O J_
Viscosity function	VM	Viscosity computing function for liquids	only with transmitter U not with mass flow and density accuracy 70, 50 only with communication type and I/O JH, JJ, JK, JL, JM, JN, G_

Option category	Options	Description	Restriction
Cable glands and blind plug	V52	2 cable glands, 1 blind plug for power, communication and I/O	not with transmitter N only with Ex approval JF5_ not with MC_
	V53	3 cable glands for power, communication and I/O	not with material wetted parts H, meter size 2H not with option MC_ for available process connections refer to tables on page [▶ 50]
Customized installation length	NL	NAMUR installation length according to NE132	not with material wetted parts H, meter size 2H
	CL	Customer-specific installation length	not with option MC_ for available process connections refer to tables on page [▶ 50]

10.4 Model code

The model code of the Rotamass Total Insight is explained below.

Items 1 through 14 are mandatory entries and must be specified at the time of ordering.

Device options (item 15) can be selected and specified individually by separating them with slashes.

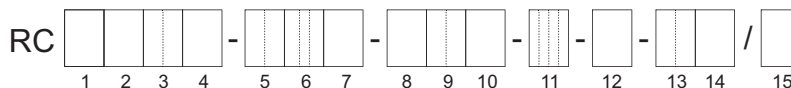

- 1 Transmitter
- 2 Sensor
- 3 Meter size
- 4 Material wetted parts
- 5 Process connection size
- 6 Process connection type
- 7 Sensor housing material
- 8 Process fluid temperature range
- 9 Mass flow and density accuracy
- 10 Design and housing
- 11 Ex approval
- 12 Cable entries
- 13 Communication type and I/O
- 14 Display
- 15 Options

10.4.1 Transmitter

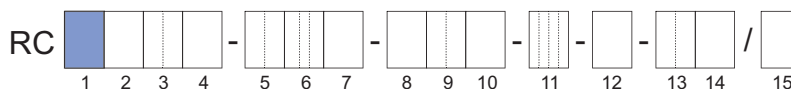

Model code position 1	Transmitter
E	Essential (base function)
U	Ultimate (high function)
N	Spare sensor without transmitter, combinable with Rotamass Total Insight transmitter

10.4.2 Sensor

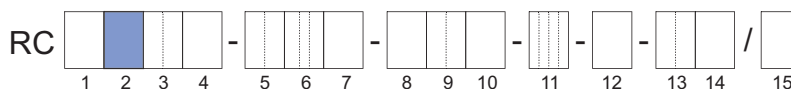

Model code position 2	Sensor
G	Giga

10.4.3 Meter size

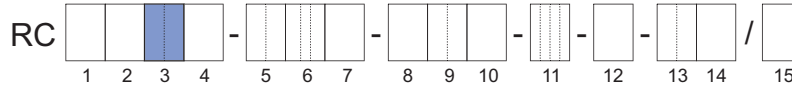

Model code position 3	Meter size	Nominal mass flow in t/h (lb/min)	Maximum mass flow in t/h (lb/min)
1F	1F	250 (9200)	300 (11000)
2H	2H	500 (18000)	600 (22000)

10.4.4 Material wetted parts

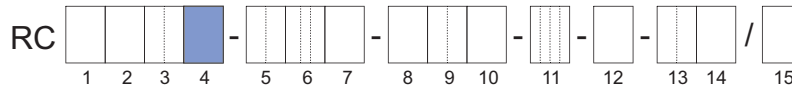

Model code position 4	Material wetted parts
S	Stainless steel 1.4404/316L
H	Ni alloy C-22/2.4602 (only available for Giga 1F)

Non-wetted parts of the process connection are generally made of stainless steel 1.4404/316L.

10.4.5 Process connection size

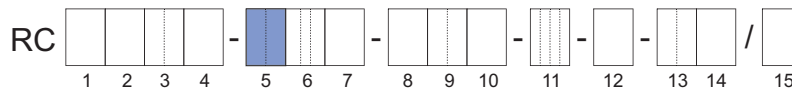

Model code position 5	Process connection size
1H	DN100, 4"
1Q	DN125, 5"
1F	DN150, 6"
2H	DN200, 8"



Available sizes depend on the actual process connection, see also chapter *Process connections, dimensions and weights of sensor* [▶ 42].

10.4.6 Process connection type

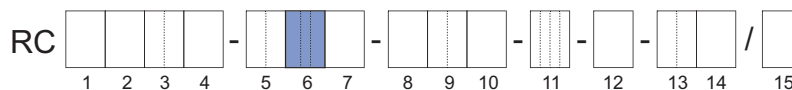

Model code position 6	Type	Process connections
BA1	Flanges suitable for ASME B16.5	ASME flange class 150, raised face (RF)
BA2		ASME flange class 300, raised face (RF)
BA4		ASME flange class 600, raised face (RF)
CA4		ASME flange class 600, ring joint (RJ)

Model code position 6	Type	Process connections
BD2	Flange suitable for EN 1092-1	EN flange PN16, type B1, raised face (RF)
ED2		EN flange PN16, type E, with spigot
FD2		EN flange PN16, type F, with recess
GD2		EN flange PN16, type D, with groove
BD4		EN flange PN40, type B1, raised face (RF)
ED4		EN flange PN40, type E, with spigot
FD4		EN flange PN40, type F, with recess
GD4		EN flange PN40, type D, with groove
BD5		EN flange PN63, type B1, raised face (RF)
ED5		EN flange PN63, type E, with spigot
FD5		EN flange PN63, type F, with recess
GD5		EN flange PN63, type D, with groove
BD6		EN flange PN100, type B1, raised face (RF)
ED6		EN flange PN100, type E, with spigot
FD6		EN flange PN100, type F, with recess
GD6		EN flange PN100, type D, with groove
BJ1	Flange suitable for JIS B 2220	JIS flange 10K
BJ2		JIS flange 20K

10.4.7 Sensor housing material

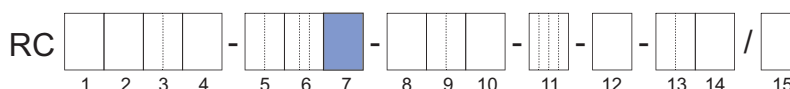

Model code position 7	Housing material
0	Stainless steel 1.4301/304, 1.4404/316L
1	Stainless steel 1.4404/316L

10.4.8 Process fluid temperature range

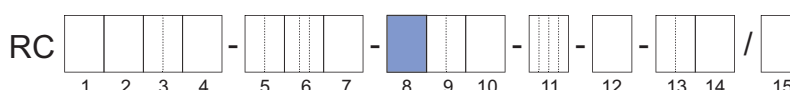

Model code position 8	Temperature range	Process fluid temperature range
0	Standard	Integral type: -50 – 150 °C (-58 – 302 °F) Remote type: -70 – 150 °C (-94 – 302 °F)
2	Mid-range	-70 – 230 °C (-94 – 446 °F)
3	High	0 – 350 °C (32 – 662 °F)

For temperature range limits, see chapter *Process fluid temperature range* [▶ 26].

10.4.9 Mass flow and density accuracy

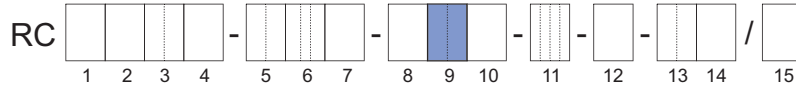

Model code position 9	Fluid	Maximum deviation	
		Mass flow D_0 in %	Density in g/l
E7	Liquid	0.2	4
C5		0.1	2
70	Gas	0.75	–
50		0.5	–

10.4.10 Design and housing

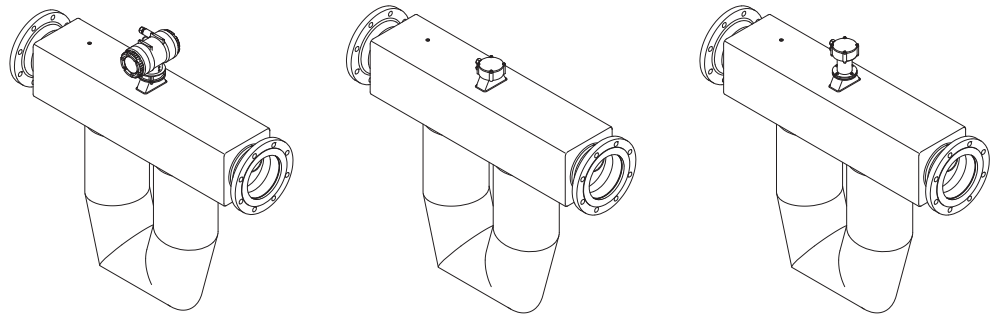
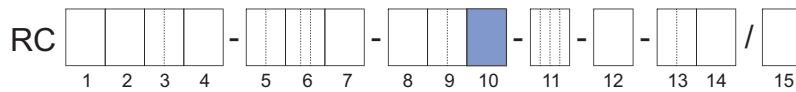

Model code position 10	Design type	Transmitter housing material	Transmitter housing coating	Sensor terminal box material	Long neck
0	Integral type	Aluminum	Standard coating	–	–
2			Corrosion protection coating		
A	Remote type	Aluminum	Standard coating	Stainless steel	No
B			Corrosion protection coating		Yes
E			Standard coating		No
F			Corrosion protection coating		Yes
J		Stainless Steel	–		No
K			–		Yes

The remote type requires a connecting cable to connect sensor and transmitter. It can be selected in various lengths as a device option, see *Connecting cable type and length* [112].

10.4.11 Ex approval

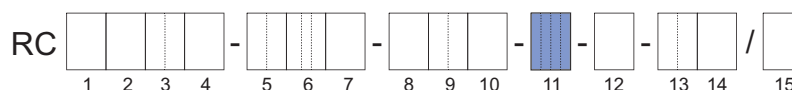

Model code position 11	Ex approval
NN00	None
KF21	ATEX, explosion group IIC and IIIC
KF22	ATEX, explosion group IIB and IIIC
SF21	IECEx, explosion group IIC and IIIC
SF22	IECEx, explosion group IIB and IIIC
FF11	FM, group A, B, C, D, E, F, G
FF12	FM, group C, D, E, F, G
GF21	EAC Ex, explosion group IIC and IIIC
GF22	EAC Ex, explosion group IIB and IIIC
UF21	INMETRO, explosion group IIC and IIIC
UF22	INMETRO, explosion group IIB and IIIC
NF21	NEPSI, explosion group IIC and IIIC
NF22	NEPSI, explosion group IIB and IIIC
PF21	Korea Ex, explosion group IIC and IIIC
PF22	Korea Ex, explosion group IIB and IIIC
JF52	Japan Ex, Temperature class T2, explosion group IIC
JF53	Japan Ex, Temperature class T3, explosion group IIC
JF54	Japan Ex, Temperature class T4, explosion group IIC

10.4.12 Cable entries

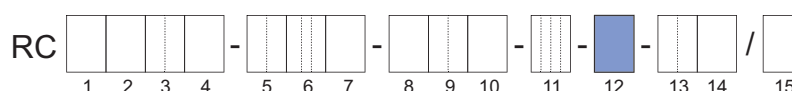

Model code position 12	Cable entries
2	ANSI ½" NPT
4	ISO M20x1.5

10.4.13 Communication type and I/O

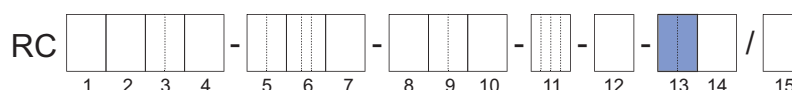

HART I/O

Model code position 13	Connection terminal assignment				
	I/O1 +/-	I/O2 +/-	I/O3 +/-	I/O4 +/-	WP
JA	Iout1 Active	P/Sout1 Passive	–	–	Write-protect
JB	Iout1 Active	P/Sout1 Passive	P/Sout2 Passive	Iout2 Active	Write-protect
JC	Iout1 Active	P/Sout1 Passive	Sin	Iout2 Active	Write-protect

Model code position 13	Connection terminal assignment				
	I/O1 +/-	I/O2 +/-	I/O3 +/-	I/O4 +/-	WP
JD	Iout1 Active	P/Sout1 Passive	Sout Passive	P/Sout2 Passive	Write-protect
JE	Iout1 Active	P/Sout1 Passive	Sin	P/Sout2 Passive	Write-protect
JF	Iout1 Active	P/Sout1 Passive	Sin	P/Sout2 Active Internal pull-up resistor	Write-protect
JG	Iout1 Active	P/Sout1 Passive	Sin	P/Sout2 Active	Write-protect
JH	Iout1 Active	P/Sout1 Passive	Iout2 Passive	Iin Active	Write-protect
JJ	Iout1 Active	P/Sout1 Passive	P/Sout2 Passive	Iin Active	Write-protect
JK	Iout1 Active	P/Sout1 Passive	Sin	Iin Active	Write-protect
JL	Iout1 Active	P/Sout1 Passive	Iout2 Passive	Iin Passive	Write-protect
JM	Iout1 Active	P/Sout1 Passive	P/Sout2 Passive	Iin Passive	Write-protect
JN	Iout1 Active	P/Sout1 Passive	Sin	Iin Passive	Write-protect

Iout1 Analog current output with HART communication

Iout2 Analog current output

Iin Analog current input

P/Sout1 Pulse or status output

P/Sout2 Pulse or status output

Sin Status input

Sout Status output

**HART I/O,
intrinsically safe**

Model code position 13	Connection terminal assignment				
	I/O1 +/-	I/O2 +/-	I/O3 +/-	I/O4 +/-	WP
JP	lout1 Passive	P/Sout1 Passive	lout2 Passive	–	Write-protect
JQ	lout1 Passive	P/Sout1 Passive	lout2 Passive	P/Sout2 Passive	Write-protect
JR	lout1 Passive	P/Sout1 Passive NAMUR	lout2 Passive	–	Write-protect
JS	lout1 Passive	P/Sout1 Passive NAMUR	lout2 Passive	P/Sout2 Passive NAMUR	Write-protect

lout1 Analog current output with HART communication

lout2 Analog current output

P/Sout1 Pulse or status output

P/Sout2 Pulse or status output

Intrinsically safe outputs are only available in combination with selecting Ex approval of the device, see chapter *Ex approval* [▶ 107].

Modbus I/O

Model code position 13	Connection terminal assignment						
	I/O1 +/-	I/O2 +/-	I/O3 +	I/O3 -	I/O4 +	I/O4 -	WP
M0	–	P/Sout1 Passive	–	Modbus C	Modbus B	Modbus A	Write- protect
M2	lin Active	P/Sout1 Passive	–	Modbus C	Modbus B	Modbus A	Write- protect
M3	P/Sout2 Passive	P/Sout1 Passive	–	Modbus C	Modbus B	Modbus A	Write- protect
M4	P/Sout2 Active	P/Sout1 Passive	–	Modbus C	Modbus B	Modbus A	Write- protect
M5	P/Sout2 Active Internal pull-up resistor	P/Sout1 Passive	–	Modbus C	Modbus B	Modbus A	Write- protect
M6	lout1 Active	P/Sout1 Passive	–	Modbus C	Modbus B	Modbus A	Write- protect
M7	lin Passive	P/Sout1 Passive	–	Modbus C	Modbus B	Modbus A	Write- protect

lout Analog current output, no HART

lin Analog current input

P/Sout1 Pulse or status output

P/Sout2 Pulse or status output

PROFIBUS PA

Model code position 13	Connection terminal assignment				
	I/O1 +/-	I/O2 +/-	I/O3 +/-	I/O4 +/-	WP
G0	PROFIBUS PA	Pulse Passive	–	–	Write-protect
G1	PROFIBUS PA (IS)	Pulse Passive (IS)	–	–	Write-protect

PROFIBUS PA PA communication
 Pulse Passive Pulse / Frequency output

Intrinsically safe (IS) outputs are only available in combination with selecting Ex approval of the device, see chapter *Ex approval* [107].

Spare sensor I/O

Model code position 13	Specification
NN	Spare sensor without transmitter, all communication types and I/Os apply

10.4.14 Display

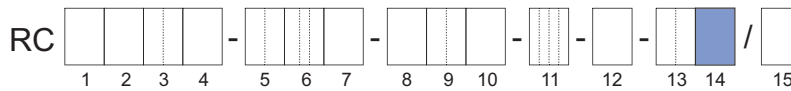

The display unit includes a slot for the microSD card.

Model code position 14	Display
0	Without display
1	With display
N	Spare sensor without transmitter, no display applied

Devices without a display are available for Essential transmitters only (value E in model code position 1).

10.5 Options

Additional device options that can be combined may be selected; they are listed sequentially in model code position 15. In this case, each device option is preceded by a slash.

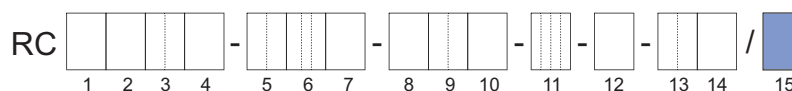

The following device options are possible:

- Connecting cable length, see chapter *Connecting cable type and length* [▶ 112].
- Customer-specific adaptation of the nameplate, see chapter *Additional nameplate information* [▶ 112].
- Flow meter presetting with customer parameters, see chapter *Presetting of customer parameters* [▶ 112].
- Concentration and petroleum measurement, see chapter *Concentration and petroleum measurement* [▶ 113].
- Batching function, see chapter *Batching function* [▶ 113].
- Viscosity function, see chapter *Viscosity function* [▶ 113].
- Insulation and heat tracing, see chapter *Insulation and heat tracing* [▶ 114].
- Certificates to be supplied, see chapter *Certificates* [▶ 114].
- Country-specific delivery, see chapter *Country-specific delivery* [▶ 117].
- Country-specific application, see chapter *Country-specific application* [▶ 117].
- Rupture disc, see chapter *Rupture disc* [▶ 117].
- Tube Health Check, see chapter *Tube Health Check* [▶ 117].
- Transmitter housing rotated 180°, see chapter *Transmitter housing rotated 180°* [▶ 118].
- Measurement of heat quantity, see chapter *Measurement of heat quantity* [▶ 118].
- Marine type approval, see chapter *Marine approval* [▶ 119].
- Cable glands and blind plug, see chapter *Cable glands and blind plug* [▶ 119].
- Customized installation length, see chapter *Customized installation length* [▶ 119].

10.5.1 Connecting cable type and length

When ordering the remote type it is mandatory to select one of the below shown connecting cable lengths.

It is possible to order cables with higher length than the maximum cable length and termination kits separately . For this purpose please check the "Customers Maintenance Parts List" (Ref.: CMPL 01U10B00-00EN-R) or consult our Yokogawa Service team.

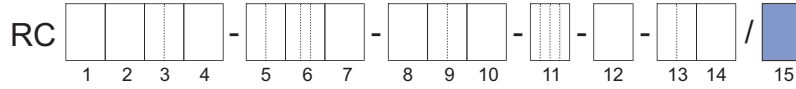

Options	Specification
L000	without standard connecting cable ¹⁾
L005	5 meter (16.4 ft) remote connecting cable terminated std. gray / Ex blue
L010	10 meter (32.8 ft) remote connecting cable terminated std. gray / Ex blue
L015	15 meter (49.2 ft) remote connecting cable terminated std. gray / Ex blue
L020	20 meter (65.6 ft) remote connecting cable terminated std. gray / Ex blue
L030	30 meter (98.4 ft) remote connecting cable terminated std. gray / Ex blue
Y000	without fire retardant connecting cable ¹⁾
Y005	5 meter (16.4 ft) remote fire retardant connecting cable, not terminated
Y010	10 meter (32.8 ft) remote fire retardant connecting cable, not terminated
Y015	15 meter (49.2 ft) remote fire retardant connecting cable, not terminated
Y020	20 meter (65.6 ft) remote fire retardant connecting cable, not terminated
Y030	30 meter (98.4 ft) remote fire retardant connecting cable, not terminated

¹⁾ Even without cables, it is necessary to select this option, because the device name plate shows the allowed ambient temperature depending on the selected cable type (see chapter [▶ 32]).

Fire retardant cable is mandatory for DNV GL type approval (options MC2 and MC3). The minimum permissible ambient temperature for the two cable types differs (see chapter *Allowed ambient temperature for sensor* [▶ 32]). The cable type intended to be used needs to be indicated (with option L000 or Y000) even if connecting cable is ordered separately.

10.5.2 Additional nameplate information

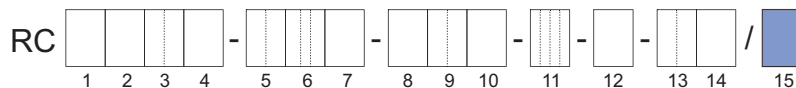

Options	Specification
BG	Nameplate with customer device location identification

This marking (Tag No.) must be provided by the customer at the time the order is placed.

10.5.3 Presetting of customer parameters

Rotamass flow meters can be preconfigured with customer-specific data.

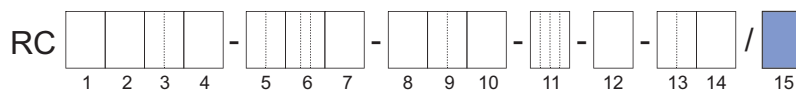

Options	Specification
PS	Presetting according to customer parameters.

10.5.4 Concentration and petroleum measurement

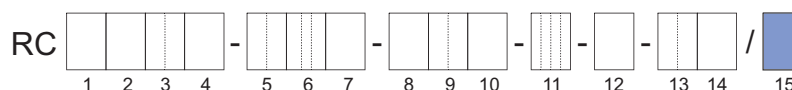

Options	Specification
CST	Standard concentration measurement
AC0	Advanced concentration measurement, customer settings
AC1	Advanced concentration measurement, one default data set
AC2	Advanced concentration measurement, two default data sets
AC3	Advanced concentration measurement, three default data sets
AC4	Advanced concentration measurement, four default data sets
C52	Net Oil Computing (NOC) following API standard

These device options are not available in combination with gas measurement devices (model code position 9 with the values: 70 or 50).

Options with CST, AC_ and C52 are available only for Ultimate transmitters (value U in model code position 1).

Advanced concentration function can be ordered with 1 to 4 different sets of pre-configured concentrations (AC1 – AC4).

For details about the device function refer to *Concentration and petroleum measurement* [▶ 70].

10.5.5 Batching function

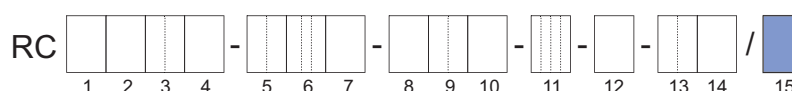

Options	Specification
BT	Batching and filling function

For details about the device function refer to *Batching function* [▶ 72].

10.5.6 Viscosity function

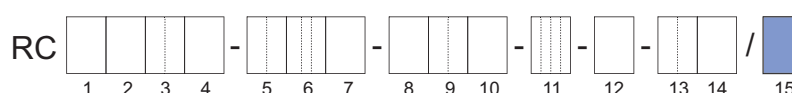

Options	Specification
VM	Viscosity computing function for liquids

For details about the device function refer to *Viscosity function* [▶ 73].

10.5.7 Insulation and heat tracing

These device options are available only for remote type with long neck.

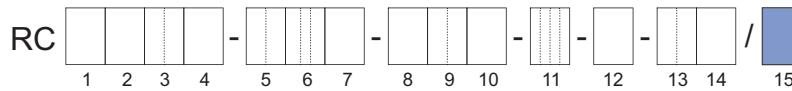

Options	Specification
T10	Insulation
T21	Insulation and heat tracing, 1/2" ASME class 150, raised face
T22	Insulation and heat tracing, 1/2" ASME class 300, raised face
T26	Insulation and heat tracing, EN DN15 PN40
T31	Insulation, heat tracing with ventilation, 1/2" ASME class 150, raised face
T32	Insulation, heat tracing with ventilation, 1/2" ASME class 300, raised face
T36	Insulation, heat tracing with ventilation, EN DN15 PN40

Material of components

Component	Material
Insulation housing	Stainless steel 1.4301/304
Insulation material	Mineral wool (rock wool)
Heat tracing and ventilation lines	Stainless steel 1.4301/1.4306/304 and 1.4404/316L
Heat tracing and ventilation connections	Stainless steel 1.4404/316L; flanges acc. ASME or EN

For dimensions of insulation and heat tracing components see *Process connections, dimensions and weights of sensor* [▶ 42].



Insulation and heat tracing is not available for process meter size 2H.

10.5.8 Certificates

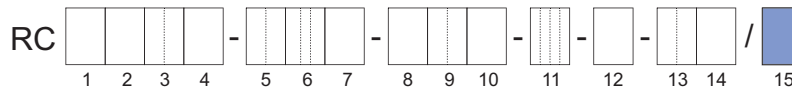

Accordance with terms of order

Options	Specification
P2	Declaration of compliance with the order 2.1 according to EN 10204
P3	Quality Inspection Certificate (Inspection Certificate 3.1 according to EN 10204)

Material certificates

Options	Specification
P6	Certificate of Marking Transfer and Raw Material Certificates (Inspection Certificate 3.1 according to EN 10204), including IGC and conform to NACE MR0175 and MR0103

For details and exceptions please refer to Rota Yokogawa declaration about NACE conformity, document no. 8660001.

Dye penetrant test of weld seams

Options	Specification
PT	Dye penetrant test of process connection weld seams according to DIN EN ISO 3452-1, including certificate
PTA	Dye penetrant test of flange welding according to ASME V, including certificate

Positive Material Identification of wetted parts

Options	Specification
PM	Positive Material Identification of wetted parts, including certificate (Inspection Certificate 3.1 according to EN 10204)

Pressure testing	Options	Specification
	P8	

Welding certificates	Options	Specification
	WP	Welding certificates: <ul style="list-style-type: none"> ▪ WPS according to DIN EN ISO 15609-1 ▪ WPQR according to DIN EN ISO 15614-1 ▪ WQC according to DIN EN 287-1 or DIN EN ISO 6906-4
	WPA	Welding procedures and Certificate according to ASME IX

Only for the butt welding seam between the process connection and the flow divider.

Mass flow calibration	Options	Specification
	K2	Customer-specific 5-point mass flow calibration with measuring range on factory calibration certificate (mass flow or volume flow of water). A table listing the desired calibration points must be supplied with the order.
	K5	Customer-specific 10-point mass flow calibration with measuring range on DAkkS calibration certificate (mass flow or volume flow of water). A table listing the desired calibration points must be supplied with the order.

Water is used as fluid for calibrating the Rotamass.

Calibration certificates	Options	Specification
	L2	The certificate confirms that the delivered instrument has undergone a calibration traceable to national standards, including a list of working standards used for calibration. Language: English/Japanese
	L3	The certificate confirms that the delivered instrument has undergone a calibration traceable to national standards, including a list of primary standards to which the delivered product is traceable. Language: English/Japanese
	L4	The certificate confirms that the delivered instrument has undergone a calibration traceable to national standards and that the calibration system of Rota Yokogawa is traceable to national standards. Language: English/Japanese

Surfaces free of oil and grease	Options	Specification
	H1	Degreasing of wetted surfaces according to ASTM G93-03 (Level C), including test report

X-ray inspection of flange weld seam	Options	Specification
	RT	X-ray inspection of flange weld seam according to DIN EN ISO 17636-1/B Evaluation according to AD 2000 HP 5/3 and DIN EN ISO 5817/C, including certificate
	RTA	X-ray test according to ASME V

This device option is not available for devices with wetted parts made of Ni alloy C-22/2.4602.

Ferrite testing	Options	Specification
	FE	Ferrite test for flange welding according to DIN EN ISO 8249

Determination of ferrite content is possible for flange weld seams according to DIN EN ISO 8249 and ANSI/AWS A4.2. The pass criterion is a ferrite number < 30. An inspection certificate is delivered with the device.

Combined certificates

Options	Specification
P10	Combination of: <ul style="list-style-type: none"> ▪ P3: Quality Inspection Certificate ▪ P6: Certificate of Marking Transfer and Raw Material Certificates ▪ P8: Hydrostatic Pressure Test Certificate
P11	Combination of: <ul style="list-style-type: none"> ▪ P3: Quality Inspection Certificate ▪ P6: Certificate of Marking Transfer and Raw Material Certificates ▪ PM: Positive Material Identification of wetted parts
P12	Combination of: <ul style="list-style-type: none"> ▪ P3: Quality Inspection Certificate ▪ P6: Certificate of Marking Transfer and Raw Material Certificates ▪ PT: Dye penetrant test according to DIN EN ISO 3452-1 ▪ P8: Hydrostatic Pressure Test Certificate
P13	Combination of: <ul style="list-style-type: none"> ▪ P3: Quality Inspection Certificate ▪ P6: Certificate of Marking Transfer and Raw Material Certificates ▪ PT: Dye penetrant test according to DIN EN ISO 3452-1 ▪ PM: Positive Material Identification of wetted parts ▪ P8: Hydrostatic Pressure Test Certificate ▪ WP: Welding certificates
P14	Combination of: <ul style="list-style-type: none"> ▪ PM: Positive Material Identification of wetted parts ▪ P8: Hydrostatic Pressure Test Certificate ▪ WP: Welding certificates
P20	Combination of: <ul style="list-style-type: none"> ▪ PTA: Dye penetrant test of flange welding according to ASME V ▪ WPA: Welding procedures and Certificates according to ASME IX ▪ RTA: X-ray test according to ASME V
P21	Combination of: <ul style="list-style-type: none"> ▪ P3: Quality Inspection Certificate ▪ P6: Certificate of Marking Transfer and Raw Material Certificates ▪ P8: Hydrostatic Pressure Test Certificate ▪ PTA: Dye penetrant test of flange welding according to ASME V ▪ WPA: Welding procedures and Certificates according to ASME IX ▪ RTA: X-ray test according to ASME V
P22	Combination of: <ul style="list-style-type: none"> ▪ P3: Quality Inspection Certificate ▪ P6: Certificate of Marking Transfer and Raw Material Certificates ▪ PM: Positive Material Identification of wetted parts ▪ PTA: Dye penetrant test of flange welding according to ASME V ▪ WPA: Welding procedures and Certificates according to ASME IX ▪ RTA: X-ray test according to ASME V

ASME B31.3 compliance

Options	Specification
P15	ASME B31.3 compliance NORMAL FLUID SERVICE

10.5.9 Country-specific delivery

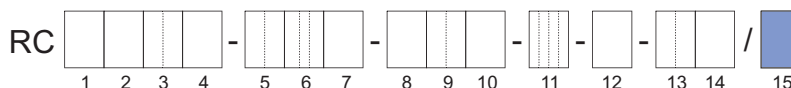

Options	Specification
PJ	Delivery to Japan incl. SI units pre-setting and Quality Inspection Certificate (EN/JP)
CN	Delivery to China including China RoHS mark
KC	Delivery to Korea including KC mark
VE	Delivery to EAEU area including EAC mark
VB	Delivery to EAEU area including EAC mark and Belarus Pattern Approval mark
VR ¹⁾	Delivery to EAEU area including EAC mark and Russia Pattern Approval mark

¹⁾ In case of combination with option TC the Dry Verification is available for the Russian Pattern Approval, which allows to check the continuation of the accuracy of the Rotamass.

10.5.10 Country-specific application

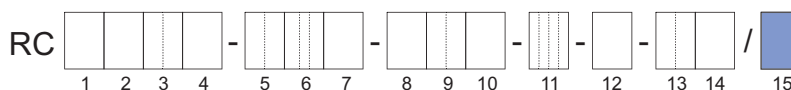

Options	Specification
Q11	PESO approval delivery
QR	Primary calibration valid in Russia, including certificate

10.5.11 Rupture disc

In the event of a measuring tube break, complete release of process pressure via the rupture disc cannot be ensured in every case.

The rupture disc's bursting pressure is 20 bar (291 psi), the nominal diameter 8 mm (0.315 inch). If a larger nominal diameter is required, the Yokogawa sales organization may be contacted with regard to customized designs.

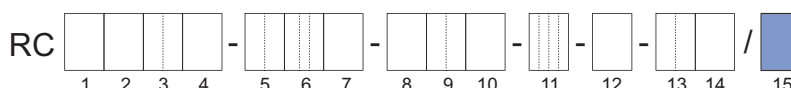

Options	Specification
RD	Rupture disc

10.5.12 Tube Health Check

By way of the Tube Health Check, the transmitter can determine whether the tube properties were altered due to corrosion or deposits and whether they could impact accuracy as a result.

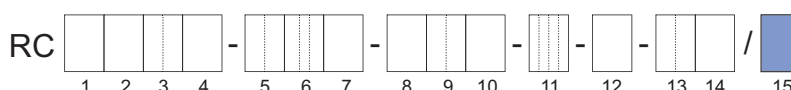

Options	Specification
TC	Tube Health Check

10.5.13 Transmitter housing rotated 180°

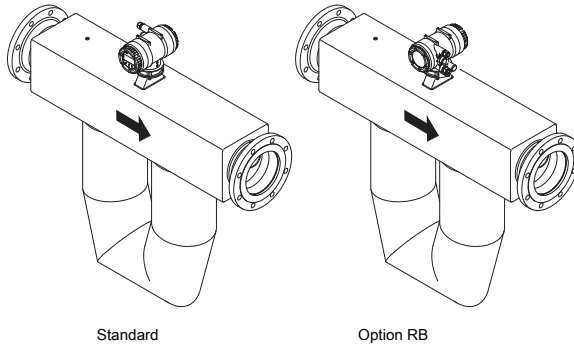
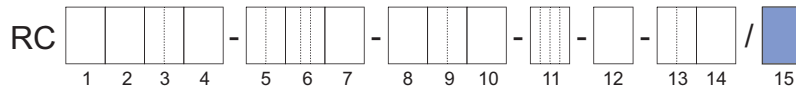

Options	Specification
RB	Alignment of transmitter housing rotated 180°

10.5.14 Measurement of heat quantity

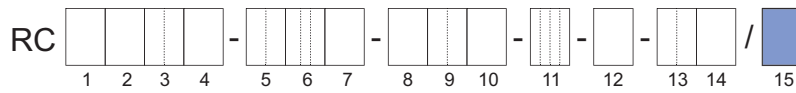

Options	Specification
CGC	Measurement of the total transported energy content of a fuel in connection with a sensor for determining the fuel's calorific value (e.g. a gas chromatograph, not included in scope of delivery). This option is available only together with model code position 13 JH to JN.

For details about the device function refer to *Measurement of heat quantity* [▶ 74].

10.5.15 Marine approval

By ordering options MC2 and MC3 the device will carry a type approval mark by DNV GL. Ordering of fire retardant cable (Y_...) is mandatory with this option. In case of thermal oil applications option RT or RTA is mandatory. Please note that DNV GL has additional requirements regarding the process conditions as reproduced in the table below. The complete requirements can be found in the classification society's rules concerning the respective use case. Marine approval is not available for all device variants, for details see exclusions in *Overview options* [96].

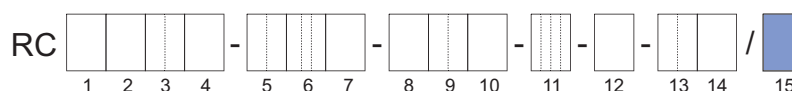

Options	Specification
MC2	Marine approval according to DNV GL piping class 2
MC3	Marine approval according to DNV GL piping class 3

	Option			
	MC2		MC3	
Piping system for	Class II ¹⁾		Class III ¹⁾	
	p in bar	T _D in °C	p in bar	T _D in °C
Steam	≤ 16	≤ 300	≤ 7	≤ 170
Thermal oil	≤ 16	≤ 300	≤ 7	≤ 150
Fuel oil, lubricating oil, flammable oil	≤ 16	≤ 150	≤ 7	≤ 60
Other media ²⁾	≤ 40	≤ 300	≤ 16	≤ 200

p : Design pressure

T_D : Design temperature

¹⁾ both specified conditions (p and T_D) shall be met

²⁾ Cargo oil pipes on oil carriers and open ended pipes (drain overflows, vents, boiler escape pipes etc.) independently of the pressure and temperature, are pertaining to class III.

10.5.16 Cable glands and blind plug

For Japan Ex Approval JF5_ following flame proof cable glands have to be ordered.

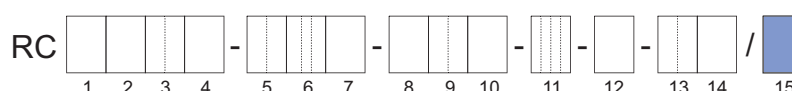

Options	Specification
V52	2 cable glands, 1 blind plug for power, communication and I/O
V53	3 cable glands for power, communication and I/O

10.5.17 Customized installation length

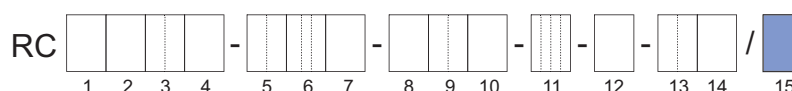

Options	Specification
NL	NAMUR installation length according to NE132
CL	Customer-specific installation length

10.5.18 Customer-specific special product manufacture

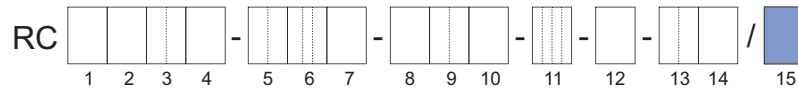

Options	Specification
Z	Deviations from the specifications in this document are possible.

10.6 Ordering Instructions

Specify the following information when ordering a product:

- Model code
- Fluid name
- Language of the quick reference instruction manual paper version:
 - English
 - French
 - German
 - Japanese
 - Chinese
 - Korean
 - Russian
- Display language and language pack (display only present for value 1 on position 14 of the model code):

pack 1	pack 2	pack 3
EN-Pack1 - English	EN-Pack2 - English	EN-Pack3 - English
DE-Pack1 - German	DE-Pack2 - German	DE-Pack3 - German
FR-Pack1 - French	RU-Pack2 - Russian	FR-Pack3 - French
PT-Pack1 - Portuguese	PL-Pack2 - Polish	PT-Pack3 - Portuguese
IT-Pack1 - Italian	KZ-Pack2 - Kazakh	IT-Pack3 - Italian
ES-Pack1 - Spanish		ES-Pack3 - Spanish
JA-Pack1 - Japanese		CN-Pack3 - Chinese

- Unit notation on the display (display only present for value 1 on position 14 of the model code):
 - Metric units
 - Imperial units - US
 - Imperial units - GB
 - Russia specific units (only available with language pack 2)
 - Japan specific units (only available with language pack 1)

- Orientation of the display (display only present for value 1 on position 14 of the model code):

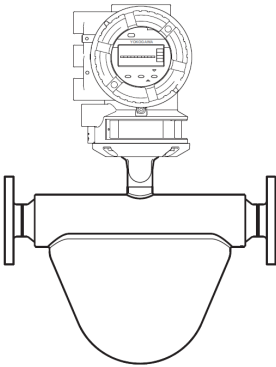
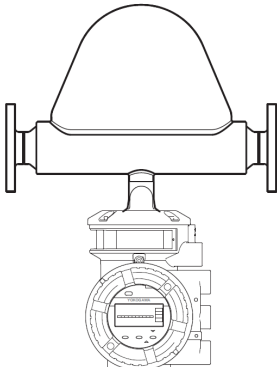
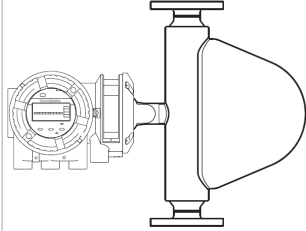
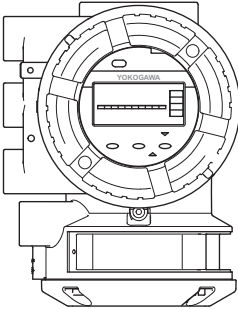
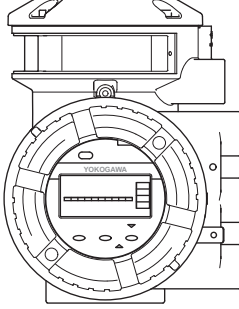
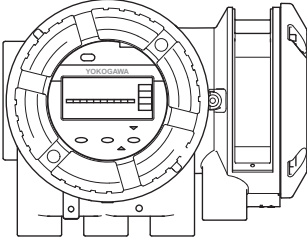
	Orientation 1	Orientation 2	Orientation 3
Integral type	<p>Horizontal installation - tubes down</p> 	<p>Horizontal installation - tubes up</p> 	<p>Vertical installation</p> 
Remote type			



In the above the figure, the case of the Prime sensor is shown. The design of sensor depend on the each series.



The parameter "Installation Orientation" in transmitter must be set by the customer according to the installation direction of the sensor.

- Tag No. engraved on the nameplate and mentioned on the calibration certificate (option BG, up to 16 characters length)
- Software Tag No.: short and long (short tag no. mentioned also on the calibration certificate):

Parameter	Value
HART Tag No. (short): up to 8 characters length (Capital letters only)	Default value has 8 space characters
HART Tag No. (long): up to 32 characters length	Default value has 32 space characters
PROFIBUS PA NODE ADDRESS (HEX): up to 4 characters length	Default value '0x7E' unless otherwise specified
PROFIBUS PA SOFTWARE TAG: up to 32 characters length	Default value 'FT2001' unless otherwise specified

- Customer name for the certificates (option L2, L3, L4: up to 60 characters length)
- Advanced concentration type (option AC1 – AC4, see *Concentration and petroleum measurement* [▶ 113]):
 - C01 Sugar / Water 0 – 85 °Bx, 0 – 80 °C
 - C02 NaOH / Water 2 – 50 WT%, 0 – 100 °C
 - C03 KOH / Water 0 – 60 WT%, 54 – 100 °C
 - C04 NH₄NO₃ / Water 1 – 50 WT%, 0 – 80 °C
 - C05 NH₄NO₃ / Water 20 – 70 WT%, 20 – 100 °C
 - C06 HCl / Water 22 – 34 WT%, 20 – 40 °C
 - C07 HNO₃ / Water 50 – 67 WT%, 10 – 60 °C
 - C09 H₂O₂ / Water 30 – 75 WT%, 4 – 44 °C
 - C10 Ethylene Glycol / Water 10 – 50 WT%, -20 – 40 °C
 - C11 Amylum = starch / Water 33 – 43 WT%, 35 – 45 °C
 - C12 Methanol / Water 35 – 60 WT%, 0 – 40 °C
 - C20 Alcohol / Water 55 – 100 VOL%, 10 – 40 °C
 - C21 Sugar / Water 40 – 80 °Bx, 75 – 100 °C
 - C30 Alcohol / Water 66 – 100 WT%, 15 – 40 °C
 - C37 Alcohol / Water 66 – 100 WT%, 10 – 40 °C

TRADEMARKS

HART:	registered trademark of FieldComm Group, Inc., US
Modbus:	registered trademark of SCHNEIDER ELECTRIC USA, INC.
PROFIBUS:	registered trademark of PROFIBUS Nutzerorganisation e.V., Karlsruhe, DE
ROTAMASS:	registered trademark of Rota Yokogawa GmbH & Co. KG, DE
FieldMate:	registered trademark of YOKOGAWA ELECTRIC CORPORATION

All other company and product names mentioned in this document are trade names, trademarks or registered trademarks of their respective companies. In this document, trademarks or registered trademarks are not marked with TM or ®.

All rights reserved. Copyright © 2019-07-01

<p>YOKOGAWA ELECTRIC CORPORATION Headquarters 2-9-32, Nakacho, Musashino-shi, Tokyo, 180-8750 JAPAN Phone : 81-422-52-5555 Branch Sales Offices Osaka, Nagoya, Hiroshima, Kurashiki, Fukuoka, Kitakyusyu</p>	<p>YOKOGAWA ELECTRIC CIS LTD. Grokholskiy per 13 Building 2, 4th Floor 129090, Moscow, RUSSIA Phone : 7-495-737-7868 Fax : 7-495-737-7869</p>	<p>YOKOGAWA INDIA LTD. Plot No.96, Electronic City Complex, Hosur Road, Bangalore - 560 100, INDIA Phone : 91-80-4158-6000 Fax : 91-80-2852-1442</p>
<p>YOKOGAWA CORPORATION OF AMERICA Head Office 12530 West Airport Blvd, Sugar Land, Texas 77478, USA Phone : 1-281-340-3800 Fax : 1-281-340-3838 Georgia Office 2 Dart Road, Newnan, Georgia 30265, USA Phone : 1-800-888-6400/ 1-770-253-7000 Fax : 1-770-254-0928</p>	<p>YOKOGAWA CHINA CO., LTD. 3F Tower D, No.568 West Tianshan RD. Shanghai CHINA, 200335 Phone : 86-21-62396262 Fax : 86-21-62387866</p>	<p>YOKOGAWA AUSTRALIA PTY. LTD. Tower A, 112-118 Talavera Road, Macquarie Park NSW 2113, AUSTRALIA Phone : 61-2-8870-1100 Fax : 61-2-8870-1111</p>
<p>YOKOGAWA AMERICA DO SUL LTDA. Praca Acapulco, 31 - Santo Amaro, São Paulo/SP, BRAZIL, CEP-04675-190 Phone : 55-11-5681-2400 Fax : 55-11-5681-4434</p>	<p>YOKOGAWA ELECTRIC KOREA CO., LTD. (Yokogawa B/D, Yangpyeong-dong 4-Ga), 21, Seonyu-ro 45-gil, Yeongdeungpo-gu, Seoul, 150-866, KOREA Phone : 82-2-2628-6000 Fax : 82-2-2628-6400</p>	<p>YOKOGAWA MIDDLE EAST & AFRICA B.S.C.(C) P.O. Box 10070, Manama, Building 577, Road 2516, Busaitteen 225, Muharra, Kingdom of SAUDI ARABIA Phone : 973-17358100 Fax : 973-17336100</p>
<p>YOKOGAWA EUROPE B. V. Euroweg 2, 3825 HD Amersfoort, THE NETHERLANDS Phone : 31-88-4641000 Fax : 31-88-4641111</p>	<p>YOKOGAWA ENGINEERING ASIA PTE. LTD. 5 Bedok South Road, Singapore 469270, SINGAPORE Phone : 65-6241-9933 Fax : 65-6241-2606</p>	<p> YOKOGAWA ◆</p>